



Installation Manual of Solar Module

NINGBO ULICA SOLAR CO., LTD

<http://www.ulicasolar.com>

2024. 09. 25

CONTENTS

1 INTRODUCTION	1
2 SAFETY PRECAUTIONS	1
2.1 GENERAL SAFETY	1
2.2 FIRE SAFETY	5
3 SITE SELECTION AND ANGLE	5
3.1 INSTALLATION ENVIRONMENT SELECTION	5
3.2 INCLINATION SELECTION	6
4 INSTALLATION	8
4.1 MODULE IDENTIFICATION	8
4.2 INSTALLATION SAFETY	9
4.3 INSTALLATION METHOD	10
4.4 GROUNDING	24
4.5 ELECTRICAL INSTALLATION	25
5 PV MODULE MAINTENANCE	29
5.1 VISUAL INSPECTION AND REPLACEMENT	29
5.2 CONNECTOR AND CABLE INSPECTION	31
5.3 CLEANING	31
5.4 WEEDING	33
5.5 TROUBLE SHOOTING	33
6 REPORTING TECHNICAL ISSUES AND CLAIMS	33

1 INTRODUCTION

- Firstly, thank you for choosing our product. This manual is only applicable to the installation, maintenance, and use of solar modules produced by Ningbo Ulica Solar Co., Ltd. (hereinafter referred to as "Ulica Solar"). Please read this manual carefully before operating, installing, or maintaining the modules. Failure to follow these safety instructions may result in personal injury or property damage.
- The Installation and operation of solar modules require professional skills, and only professionals can engage in this work. Please read the "Safety and installation Instructions" carefully before using and operating the modules. The installer must inform the end customers (or consumers) of the above matters accordingly.
- The term "Module" or "PV Module" in this manual refers to one or more Ulica Solar modules. Please retain this manual for future reference.

DISCLAIMER

Ulica Solar reserves the rights to change this manual without noticing in advance. This manual is not a warranty document and does not have any warranty meaning. Failure of the customers to follow the requirements outlined in this manual during the handling (including without limitation to packing/unpacking, loading/unloading, transportation, storage, installation, use, operation or maintenance, etc.) of the products will result in the invalidity of product's limited warranty. Ulica Solar

is not responsible for any damages of any kind, including but not limited to any product damages, personal injury or any other property losses, as resulting from any improper operations or faults by the customers during the handling of the products as failure to follow the instructions in this manual.



Warning

Otherwise, the product may be damaged or the user's personal safety may be endangered.



Prohibition

Otherwise, the product may be damaged or the user's personal safety may be endangered.

2 SAFETY PRECAUTIONS

2.1 GENERAL SAFETY

- Before installing, wiring, operating, or maintaining modules, all safety regulations should be read and understood. When the solar cell surface of the module is directly exposed to sunlight or other light sources, direct current (DC) will be generated. Regardless of whether the module is

- Regardless of whether the PV module is connected to the system or not, appropriate protective measures should always be taken when contacting the module, such as insulated tools, safety helmets, insulated gloves, safety belts, and safety insulated shoes. When you need to install, ground, wire, clean, and perform other operations on modules, please be sure to use appropriate electrical safety protection tools. Avoid direct contact with modules, which may cause electric shock or cuts.

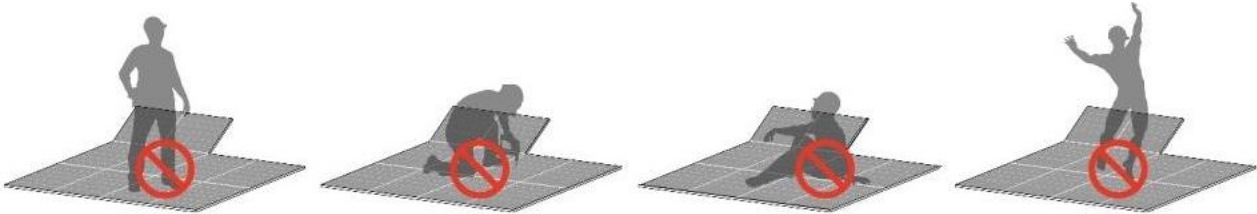
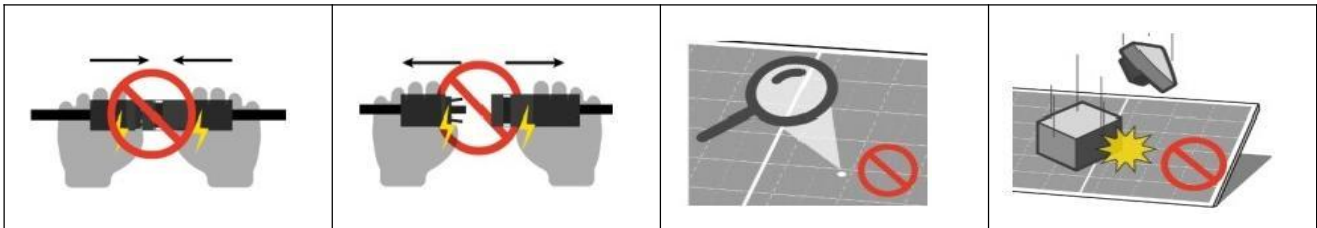

Figure 1: Do not stand, step, sit, lie down, walk or jump directly on the module or module packaging

- Do not stand, step, sit, lie down, walk or jump directly on the module or module packaging.



- The PV module does not contain any serviceable parts. Do not disassemble or move any part of the module.

Figure 2: Do not disassemble or move any part of the module. Do not artificially concentrate sunlight and impact module

- Do not damage or scratch the front- or backside surfaces of the module, as cuts may directly affect the product safety. If you detect any cuts on the module front- or backside, please do not use the module at all.
- Do not stack heavy or sharp objects on the modules.
- Do not lift the module by directly lifting or pulling the junction box or connector cables.
- Do not pull, scratch or bend the output cables with force. Otherwise, the insulation part of the output cables will be damaged, leading to current leakage or electric shock.
- Do not insert any conductive material into the connectors of the modules.
- Do not connect or disconnect the module when there is a current flow, or connected with any powered system.
- Do not use water to extinguish fires without disconnecting the power supply.
- Do not artificially concentrate sunlight on the module.
- Do not drop PV modules or allow objects to hit or fall directly on the modules.
- Do not carry modules on your head.
- Do not use ropes to carry modules.

➤ Do not carry modules on your back.

- During the normal operation of modules, they should not be blocked by buildings, trees, chimneys, etc. at any time of the day.
- Keep the junction box cover closed at all times.
- Protect junction box or connector from coming into contact with oil-based substances, organic solvents, other corrosive materials, or other substances that may cause malfunction. Further use is not allowed if junction box and connectors are contaminated.
- Junction boxes and connectors should be protected from direct sunlight and water immersion.

Commonly, a solar photovoltaic module is likely to experience conditions that produce more current and/or voltage than reported at standard test conditions. The requirement of National Electric Code (NEC) in Article 690 shall be following to address these increased outputs. In installallion not under the requirement of the NEC, the values of I_{sc} and V_{oc} marked on this module should be multiplied by a factor of 1.25 when determining component voltage ratings, conductor current ratings, fuse sizes and size of controls connected to the PV output. Factors to consider include module temperature and front side irradiance (and, for bifacial modules, ground or roof albedo, row spacing, and installation height).

2.2 FIRE SAFETY

When install modules on the rooftop, please refer to local laws and regulations before installation and abide by the requirements on building fire protection. The roof should be covered with a layer of fireproof materials and make sure that the backsheet and the mounting surface are fully ventilated. Different roof structures and installation methods will affect fireproof performance of buildings. Improper installation may lead to the risk of fire. Please use proper module accessories such as fuse, circuit breaker and grounding connector according to local regulations.



Do not install or use modules near open flames or flammable and explosive materials.

According to the Standards of UL 790, For single Glass PV module, the Spread of flame test Specification and the Burning brand test Specification is Class C; For Doualde Glass PV module, the Spread of flame test Specification is Class A and the Burning brand test Specification is Class C.

3 SITE SELECTION AND ANGLE

3.1 INSTALLATION ENVIRONMENT SELECTION

- Ulica Solar recommends modules installing environments with temperatures ranging from -40°C to 70°C .

- Modules should be installed in areas with no shadows throughout the year as much as possible. Although bypass diodes have been installed in the modules, shadows can still affect their optimal performance and operational safety.
- Do not install modules where there is a risk of water immersion or continuous exposure to sprinklers or fountains.
- When installing solar modules on the rooftop, a safe working area must be left between the roof edge and the outer edge of the PV array.
- When stacking module on the rooftop, the rooftop should tested for such loading and the installation plan must be developed in accordance with the specification requirements.
- When using the modules in areas with high wind load and snow load, the supporting structure design should be carried out in strict accordance with the local design specifications, to ensure that the external load does not exceed the mechanical strength limit that the modules can withstand.
- Salt spray corrosion tests conducted in accordance with IEC 61701 have shown that Ulica Solar's PV modules can be installed near offshore or in the corrosive environment. However, the modules shall not be immersed in water or in a permanently wet environment (e.g., fountains, spindrift, etc.). There is a risk of corrosion if the module is placed in a salt spray (i.e., a marine environment) or in an environment containing sulfur (e.g., volcanoes, etc.).
- In the place, 50~500 m away from the sea, stainless steel or aluminum materials must be used to install the PV modules, and the installation position must be processed with anti-corrosion treatment.

3.2 INCLINATION SELECTION

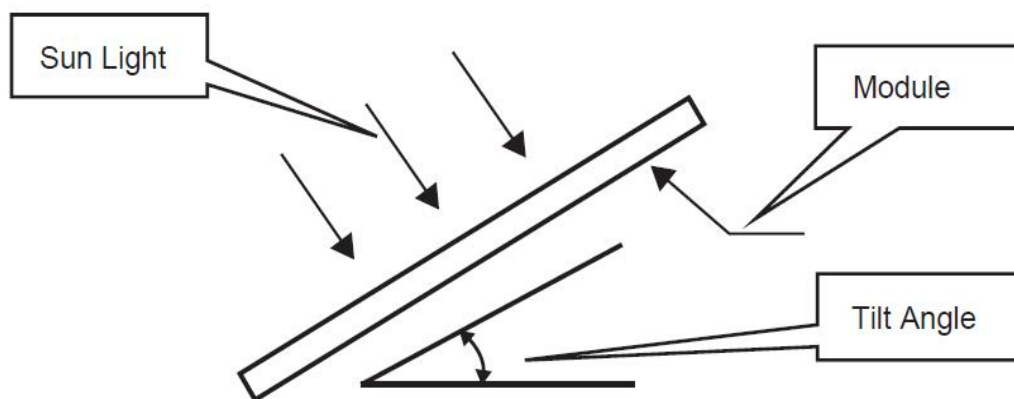

Figure 3 Schematic diagram of module installation inclination angle

- The tilt angle of the PV module refers to the angle between the module and the horizontal ground. The tilt angle shall be selected according to the local conditions for different projects. Ulica Solar recommends that the mounting tilt angle should not be less than 10°. For specific tilt angles, it shall be chosen in accordance with the local design procedures, specifications and regulations, or following the recommendations of the experienced PV module installers.
- The PV modules is highly recommended facing south in the northern hemisphere and north in the southern hemisphere to get the best performance.
- Following the local regulations, if PV modules are installed in North America and any other country or region comply to UL standard. A minimum of 100mm (3.94inch, recommended value) clearance shall be left between the PV module (backside) and the wall or roof surface. If other installation methods are used, the PV module's UL certification or fire class rating may get affected.

4 INSTALLATION

4.1 MODULE IDENTIFICATION

There are two types of labels in every module, providing the following information:

(1) Nameplate: Information such as product type, rated power, rated current, rated voltage, open-circuit voltage, short-circuit current, certification mark, and maximum system voltage under standard testing conditions.

(2) Serial Number label: Each module has a unique serial number. This serial number is printed on the barcode, placed in the module before lamination, and cannot be torn or smeared after lamination. In addition, two identical serial number can be found on or next to the module label or on the aluminum frame of the module.

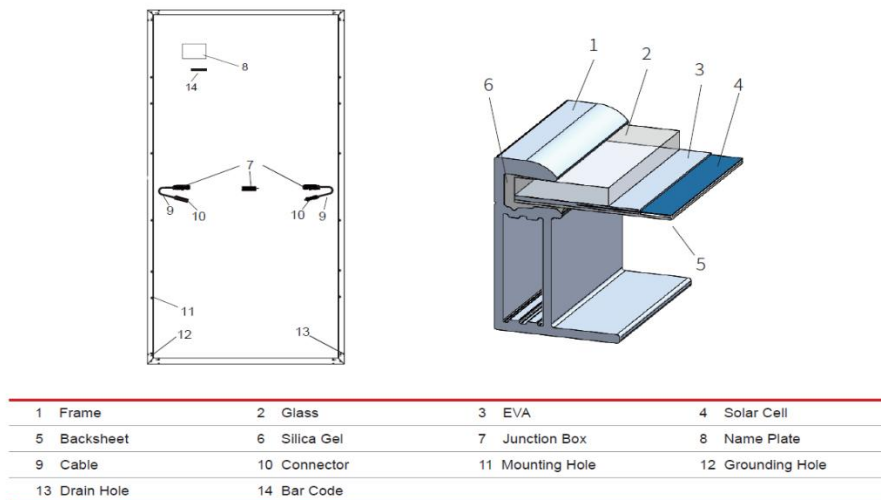

Figure 4 Schematic diagram and module description of single glass module structure

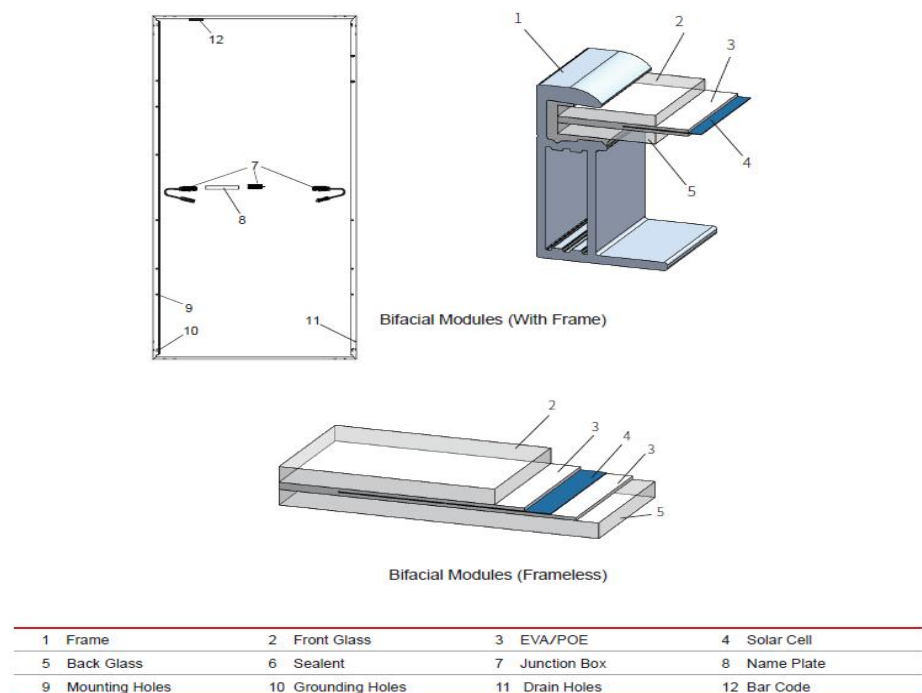

Figure 5 Schematic diagram and module description of double glass module structure

4.2 INSTALLATION SAFETY

- Ulica Solar recommends that module installation should only be conducted by specialized persons with experience in PV system installation. All installation work must be in full compliance with the local regulations and the relevant international electrical standards.
- The fire rating of Ulica Solar modules complies with relevant standards or local laws and regulations.
- Before installation, please carefully check the modules for abnormalities such as glass bursts, cell cracks, backsheet scratches, deformation of installation holes, broken junction boxes or missing covers, nameplates falling off or missing, and broken cables or connectors, etc. If any of such situation is found, please contact Ulica Solar customer service in time.
- Before installation, please keep modules' electrical components clean and dry. Connectors can corrode if they are in connected under wet conditions or with water inside the conductive parts. Any corroded components shall not be used.
- The cable length of junction box shall be selected according to the installation mode. When wiring, the ties for fixing the cables coils shall be removed. The cable shall be fixed on the installation system (frame or bracket, guide rail) with UV resistant cable ties, in cable conduits or wire cards to avoid direct sunlight or immersion in water and mechanical damage of the cable; otherwise, it may cause accelerated aging of the cable or even leakage and fire. Bifacial PV modules should also avoid blocking the solar cells on the back of the module.



- Do not install modules under rain, snow or windy conditions.
- If installing or operate modules in the morning after rain or with dew, appropriate protective measures need to be taken to prevent moisture from seeping into the connector.
- Do not allow unauthorized persons to access the installation area.
- When using scaffolding for installation, it should be ensured that the scaffolding is in a stable position or with anti-dumping measures. Installation personnel should wear safety belts in accordance with local building codes.
- It is recommended not to stand on the bottom side of the inclined surface of the module during installation, to prevent the module from slipping and causing casualty.
- Please keep the PV module packed in the carton until installation and install them immediately after unpacking.
- Do not wear metallic jewelry which can cause electric shock during installation.

- Installation work must be carried out by at least two persons.
- Do not stand on the module glass during work to avoid injury or electric shock caused by broken glass.
- Do not loosen or unscrew the screws/clamps/rails of and around the PV module, which may lead to a reduction of the module's load rating and even fall off.
- During installation and wiring of PV modules, please use opaque material to cover the PV module surface completely.
- Do not drop any tools or other objects on the front- or backside of the module, which may cause visible or invisible damage to the module.
- Do not install or use damaged modules. If the surface glass is damaged or worn, direct contact with the surface of the module may cause electric shock.
- Do not damage the backsheet or glass of modules when fastening the modules to the bracket with bolts.
- Do not drill additional holes on any part of the module, Doing so will void the warranty.
- During installation or use, the drain holes must not be blocked under any situation.
- If the system circuit is connected to the load, please do not unplug the connector.
- Modules with different colors should be avoided to install on the same rooftop or in the same array.

4.3 INSTALLATION METHOD

- The PV modules must be installed in accordance with the installation instructions specified in this manual to comply with the IEC certification. Before installing, please read this section carefully to familiarize yourself with the complete installation processes.
- The modules and racking system can be connected through the mounting holes, clamps, or an embedded system. Installation of modules must be carried out in accordance with the installation requirements. If you wish to use a different installation method, please consult Ulica Solar customer service or technical support team. If in such case that an alternative mounting method is used but not approved by Ulica Solar, the module may get damaged and the warranty will be invalidated.
- The mechanical loads described in this manual are the test loads. For calculating the equivalent maximum design loads, a safety factor of 1.5 (Mechanical loads=Design loads×1.5 security coefficient) needs to be considered in compliance with the requirements of the local laws and regulations. The design loads are strongly related to the construction, applied standards, location and local climate conditions; therefore, have to be determined by the racking suppliers and/or the

professional engineers. For detailed information, please follow local structural code or contact your professional structural engineer.

- The minimum distance between two modules is 5mm (0.2inch). If using special trackers, the minimum distance should be selected according to the technical requirements of the tracker suppliers.
- If the module fails due to the use of unsuitable accessories or improper installation, the Ulica Solar limited warranty will be voided.

(I) SCREW INSTALLATION

- The torque range for tightening M8 bolt is 12N•m~16N•m; The torque range for tightening M6 bolt is 8N•m~12N•m.
- When selecting Ulica Solar’s 30mm (30H) high frame module, it is recommended to choose fasteners with a length of $L \leq 20\text{mm}$ ("L" indicates bolt length). (If there are special models, you can consult Ulica Solar's customer service).
- Each frame has 8~12 installation holes with a diameter of 9*14mm or 7*10mm on its frame, which ideally placed to optimize the loading capacity to secure the modules on the supporting structure.
- To maximize mounting longevity, Ulica Solar strongly recommends the use of corrosion proof (stainless steel) fixings. All parts of the module connection should use flat stainless washers with

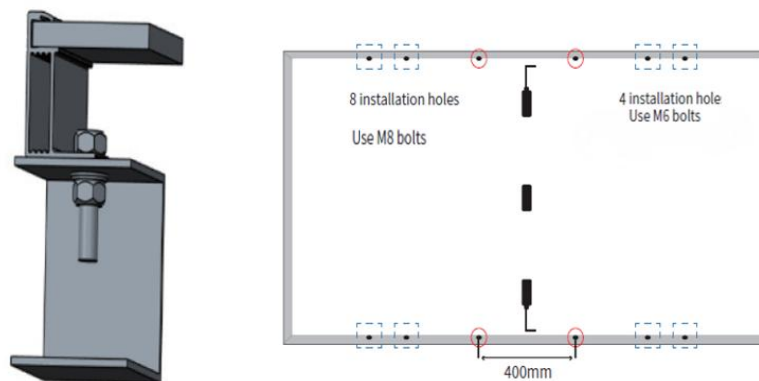

a minimum thickness of 1.8mm and an outer diameter of 20~24mm (0.79~0.94inch).

Figure 6 PV modules installed using the bolt-in method

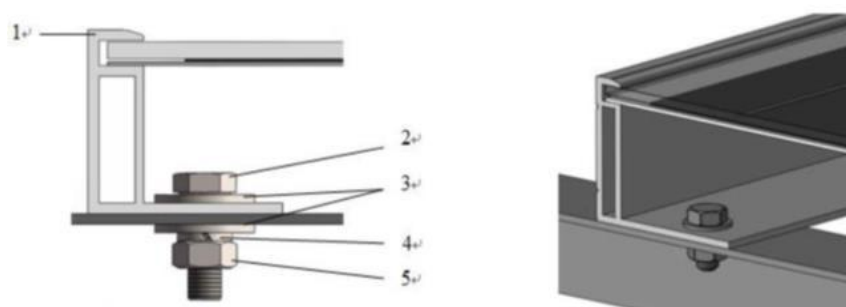

1. Aluminum frame 2. M8 stainless bolt 3. Flat stainless washer 4. Spring stainless washer 5. M8 stainless nut

Figure 7 Schematic diagram of screw installation

Recommended accessories are as below:

Accessories	Model		Material	Note
Bolt	M8 (full thread recommended)	M6 (full thread recommended)	Q235B/SUS304	Accessories material selection should be based on application environment.
Washer	2*8	2*6 (6.4*18-1.6 ISO 7093)	Q235B/SUS304	
Spring Washer	8	6	Q235B/SUS304	
Nut	M8	M6	Q235B/SUS304	

Table 1 Accessories required for installation

(II) CLAMP INSTALLATION

- Ulica Solar has tested its modules with a number of clamps from different manufacturers, it is recommended to use fixing bolt of at least M8. The clamp shall not be malfunctioned due to deformation or corrosion during the loading process. It is recommended to use a clamp with length of $\geq 50\text{mm}$ (1.97inch) and thickness of $\geq 4\text{mm}$ (0.16inch), aluminum alloy 6005-T6, Rp0.2 $\geq 225\text{MPa}$, Rm $\geq 265\text{MPa}$. (The clamp shall be selected to guaranty the module installation reliability recommended torque range is for reference only).
- The clamp must overlap the A surface of module frame by at least 8mm (0.32inch) but not more than 11mm (0.43inch).
- For installation where mounting rails run parallel to the frame, the frame must overlap the rails completely or the overlapping distance must $\geq 20\text{mm}$. As shown in Figure 8.

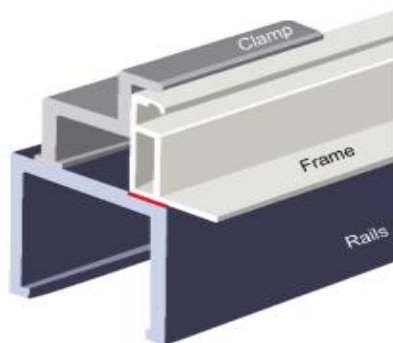
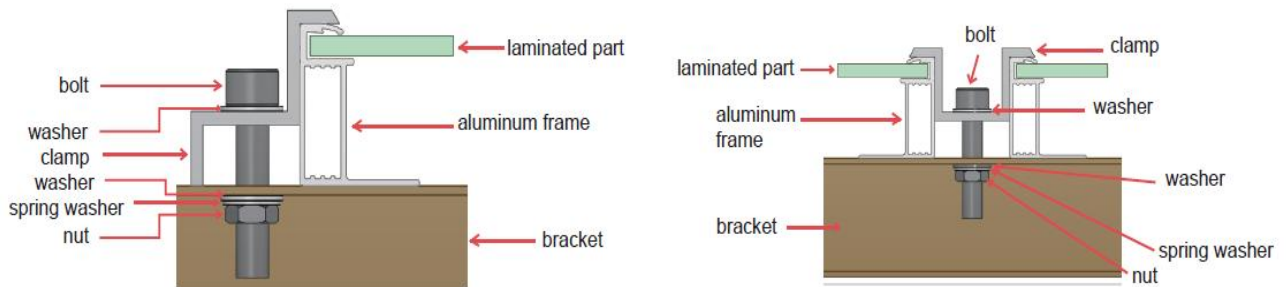

Figure 8: —The frame must overlap the rails completely or the overlapping distance must $\geq 20\text{mm}$

- Since the spec of clamps is not uniform in the market and the clamps have a large impact on the wind load resistance in system side, it is recommended to follow the recommendation of Ulica Solar to choose clamps. You can also customize the clamps by yourselves, but please make sure that the modules do not detach from the brackets and rails.
- The clamps shall not to be out the edge of the module under any circumstances.
- Please make sure to avoid shading effects from the module clamps.
- The module frame shall not to be modified under any circumstances.

- The clamp should avoid touching the glass or deforming the frame of the assembly, and the surface of the clamp in contact with the front of the frame must be flat and smooth, otherwise it will damage the frame and cause module breakage.
- When choosing clamp installation method, use at least four clamps on each module. Depending on local wind and snow loads, additional clamps may be required to ensure that modules can bear the extra load.
- Applied torque should refer to mechanical design standard according to the bolt customer is using, for example: M8: 10-14 N•m.



The installation method of the clamp is shown in the figure below:

End clamp installation

Middle clamp installation

Figure 9 Schematic diagram of clamp installation

(III) MODULE TYPE AND SPECIFICATION

Module type	Dimensions	Cell size	Cell type
UL-***M-108HV(***=400-415W)	1722*1134*30	182.2*91	P
UL-***M-120HV(***=360-380W)	1755*1038*30	182.2*91	P
UL-***M-108BHVN(***=420-465W)	1762*1134*30	182.2*94	N
UL-***M-108CHVN(***=450-475W)	1800*1134*30	182.2*95.8	N
UL-***M-120BHVN(***=480-515W)	1952*1134*30	182.2*94	N
UL-***M-144HV(***=445-460W)	2094*1038*35	166*83	P
UL-***M-144HV(***=545-560W)	2279*1134*35	182.2*91	P
UL-***M-144CHVN(***=590-620W)	2382*1134*35	182.2*95.8	N
UL-***M-132HV(***=650-670W)	2384*1303*35	210*105	P

Table 2

Monofacial of back sheet products and main specifications

Module type	Dimensions	Cell size	Cell type
UL-***M-108ADGN(***=430-440W)	1722*1134*30	182.2*91	N
UL-***M-108BDGN(***=440-460W)	1762*1134*30	182.2*94	N
UL-***M-108CDGN(***=450-485W)	1800*1134*30	182.2*95.8	N
UL-***M-120BDGN(***=490-510W)	1952*1134*30	182.2*94	N
UL-***M-144ADGN(***=565-590W)	2278*1134*30	182.2*91	N
UL-***M-156ADGN(***=590-625W)	2382*1134*30	182.2*88	N

UL-***M-144CDGN(***=600-640W)	2382*1134*30	182.2*95.8	N
UL-***M-132DG(***=650-670W)	2384*1303*35	210*105	P
UL-***M-132DGN(***=690-715W)	2384*1303*33	210*105	N

Table 3 Bifacial dual glass products and main specifications

4.3.1 MONOFACIAL OF BACK SHEET PRODUCTS

The following installation methods and mechanical loads have been verified by the Ulica Solar Laboratory for PV Science and Technology. (TUV certified installation method)

Installation methods and mechanical load of monofacial of back sheet products. ("+" indicates the downforce load and "-" indicates the uplift load)

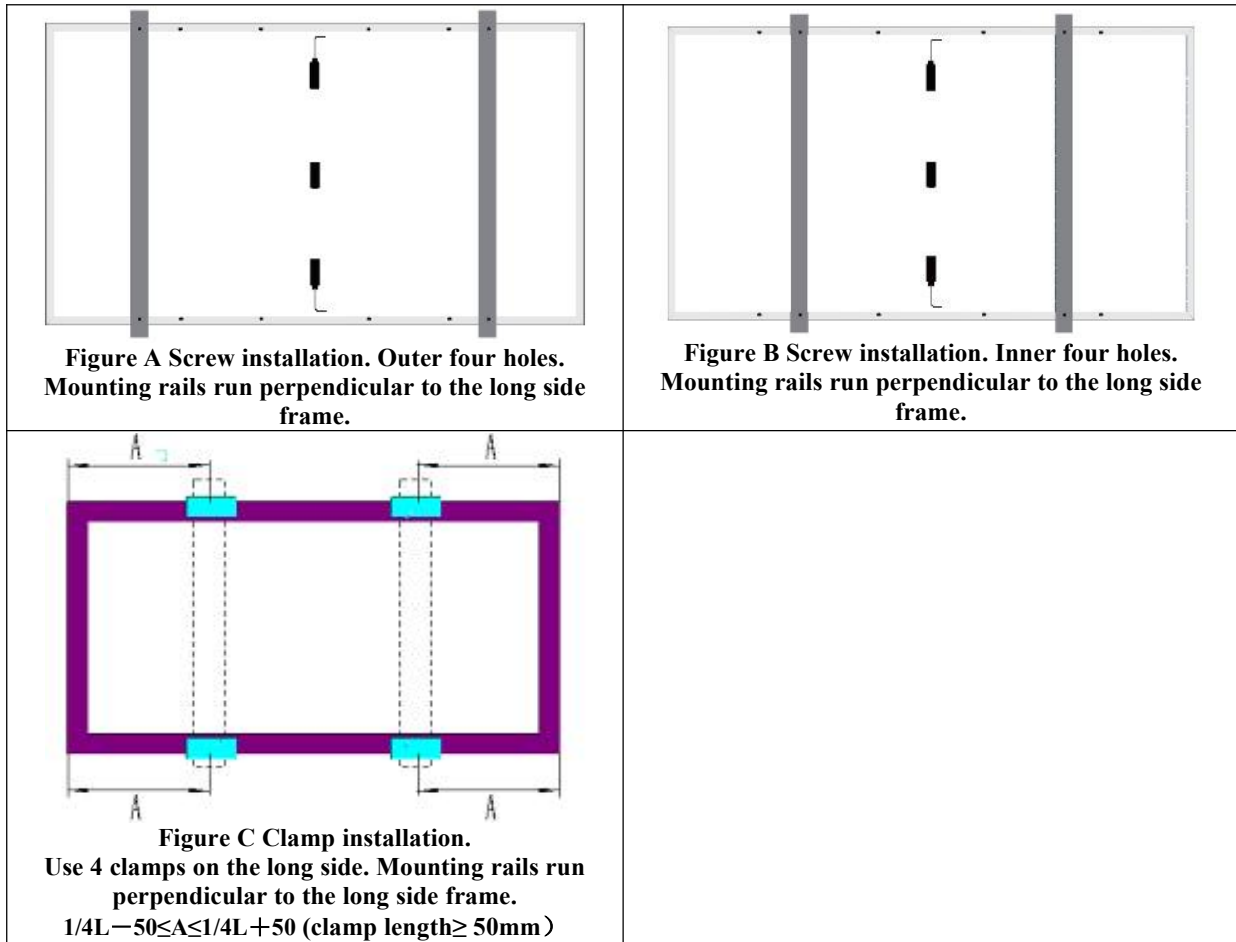
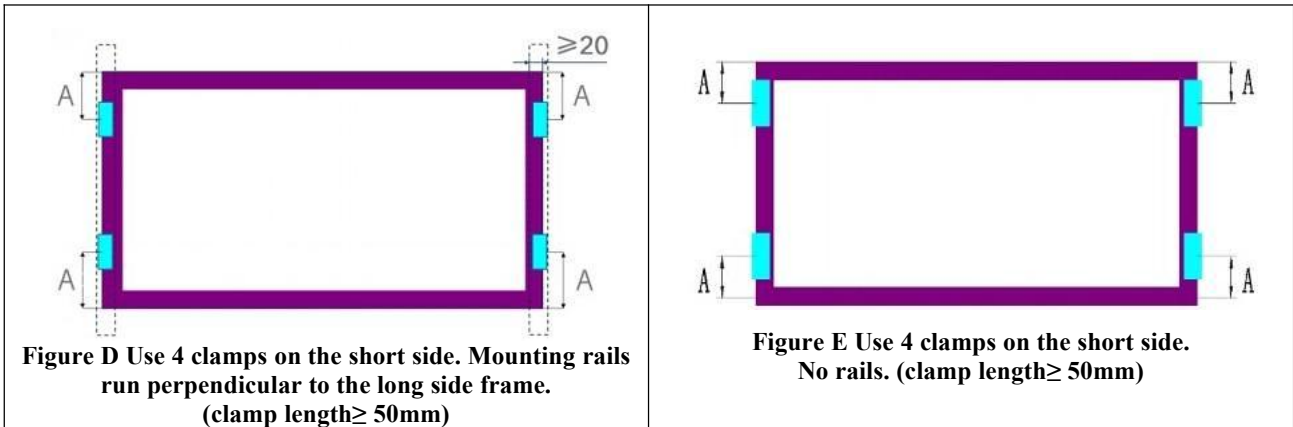

Figure 10 Schematic of different installation methods of monofacial of back sheet products

Installation method Module type	Screw installation		Clamp installation
	Figure A	Figure B	Figure C
UL-***M-108HV(***=400-415W)	+5400 -2400	+5400 -2400	+5400 -2400
UL-***M-120HV(***=360-380W)			
UL-***M-108BHVN(***=420-465W)			
UL-***M-108CHVN(***=450-475W)			
UL-***M-120BHVN(***=480-515W)		Not recommended	
UL-***M-144HV(***=445-460W)			
UL-***M-144HV(***=545-560W)			
UL-***M-144CHVN(***=590-620W)			
UL-***M-132HV(***=650-670W)			

Snow load and wind load of simple support system



Load capacities of different simple installation modes:

Module type \ Installation method	Figure D	Figure E
UL-***M-108HV(***=400-415W)	+1800 -1800 (A=150~250mm)	+1800 -1800 (A=0~250mm)
UL-***M-120HV(***=360-605W)		
UL-***M-108BHVN(***=420-465W)		
UL-***M-108CHVN(***=450-475W)		
UL-***M-120BHVN(***=480-515W)	+1300 -1100 (A=0~200mm)	+1300 -1100 (A=0~200mm)
UL-***M-144HV(***=445-460W)		
UL-***M-144HV(***=545-560W)	Not recommended	Not recommended
UL-***M-144CHVN(***=590-620W)		
UL-***M-132HV(***=650-670W)		

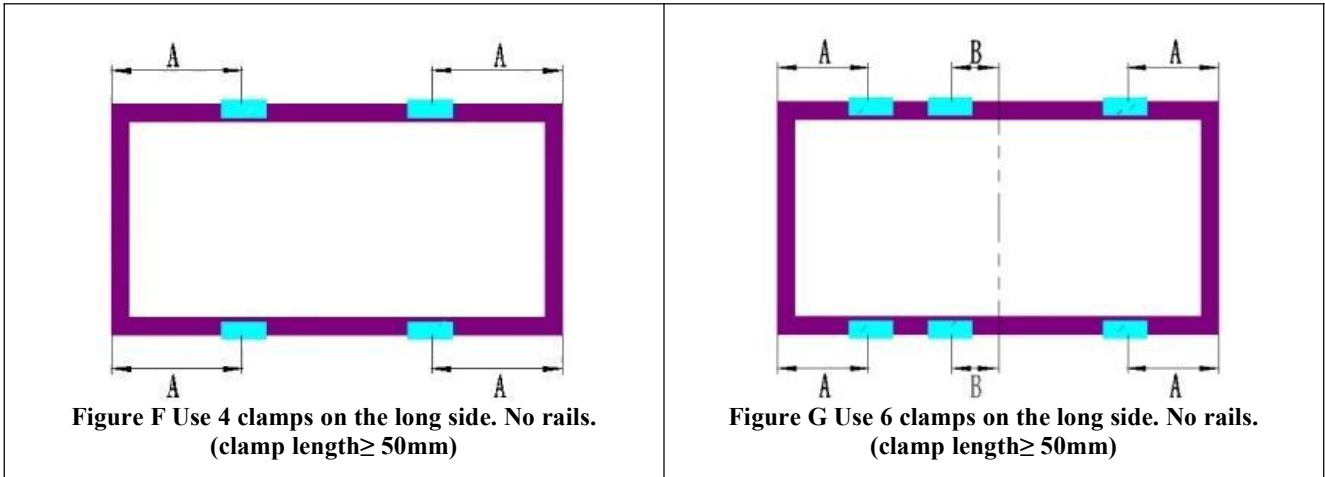

Load capacities of different simple installation modes:

Installation method Module type	Figure F	Figure G
UL-***M-108HV(***=400-415W)	+3600 -3000 (A=200~400mm)	+5400 -3800 A=(0~200)mm B=(0~200)mm
UL-***M-120HV(***=360-605W)		
UL-***M-108BHVN(***=420-465W)		
UL-***M-108CHVN(***=450-475W)		
UL-***M-120BHVN(***=480-515W)	+1700 +1700 (A=200~600mm)	+2400 -1800 A=(0~200)mm B=(0~200)mm
UL-***M-144HV(***=445-460W)		
UL-***M-144HV(***=545-560W)	+1800 -1100 (A=450~750mm)	
UL-***M-144CHVN(***=590-620W)		
UL-***M-132HV(***=650-670W)		

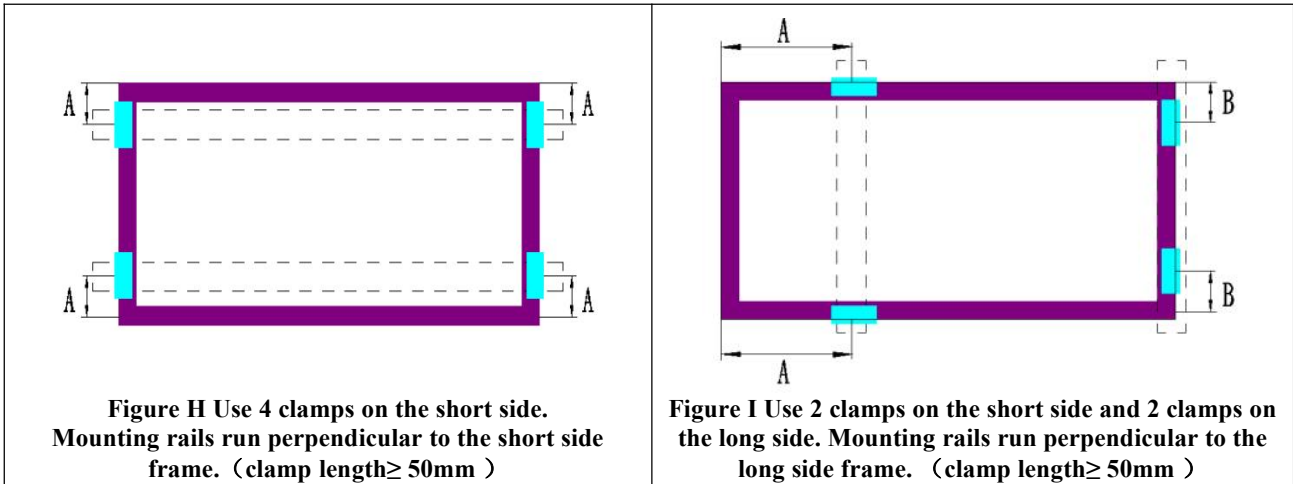

Load capacities of different simple installation modes:

Installation method Module type	Figure H	Figure I
UL-***M-108HV(***=400-415W)	+2400 -2400 (A=150~250mm)	+2400 -2400 A=(250~450)mm B=(100~250)mm
UL-***M-120HV(***=360-605W)		
UL-***M-108BHVN(***=420-465W)		
UL-***M-108CHVN(***=450-475W)		
UL-***M-120BHVN(***=480-515W)	+1600 -1000 (A=150~250mm)	+1600 -1000 A=(250~450)mm B=(100~250)mm
UL-***M-144HV(***=445-460W)		
UL-***M-144HV(***=545-560W)	Not recommended	Not recommended
UL-***M-144CHVN(***=590-620W)		
UL-***M-132HV(***=650-670W)		

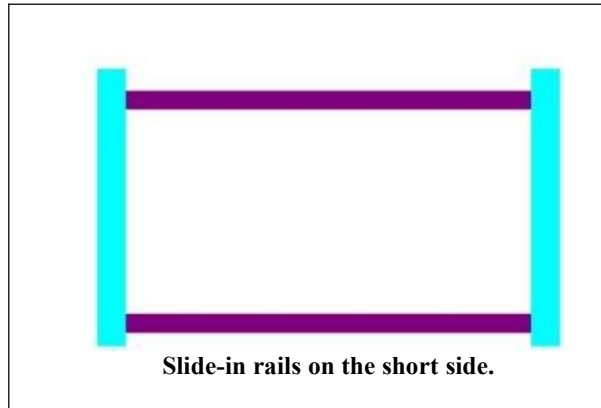

Load capacities of different simple installation modes:

Installation method Module type	Slide-in rails on the short side
UL-***M-108HV(***=400-415W)	+2200 -1600
UL-***M-120HV(***=360-605W)	
UL-***M-108BHVN(***=420-465W)	
UL-***M-108CHVN(***=450-475W)	
UL-***M-120BHVN(***=480-515W)	+1000 -1000
UL-***M-144HV(***=445-460W)	
UL-***M-144HV(***=545-560W)	Not recommended
UL-***M-144CHVN(***=590-620W)	
UL-***M-132HV(***=650-670W)	

4.3.2 BIFACIAL DUAL GALSS PRODUCTS

The following installation methods and mechanical loads have been verified by the Ulica Solar Laboratory for PV Science and Technology. (TUV certified installation method)

Installation methods and mechanical load of bifacial dual glass products. ("+" indicates the downforce load and "-" indicates the uplift load)

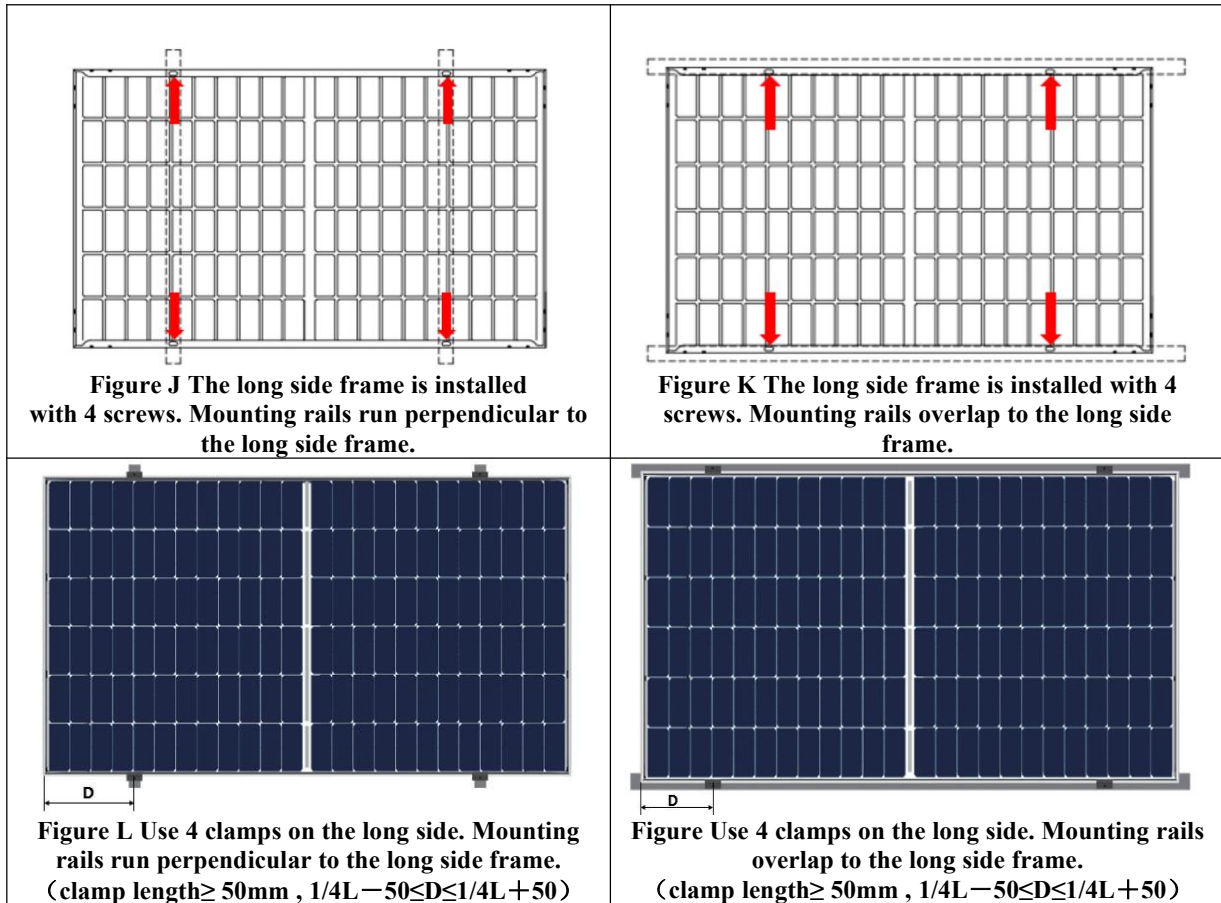
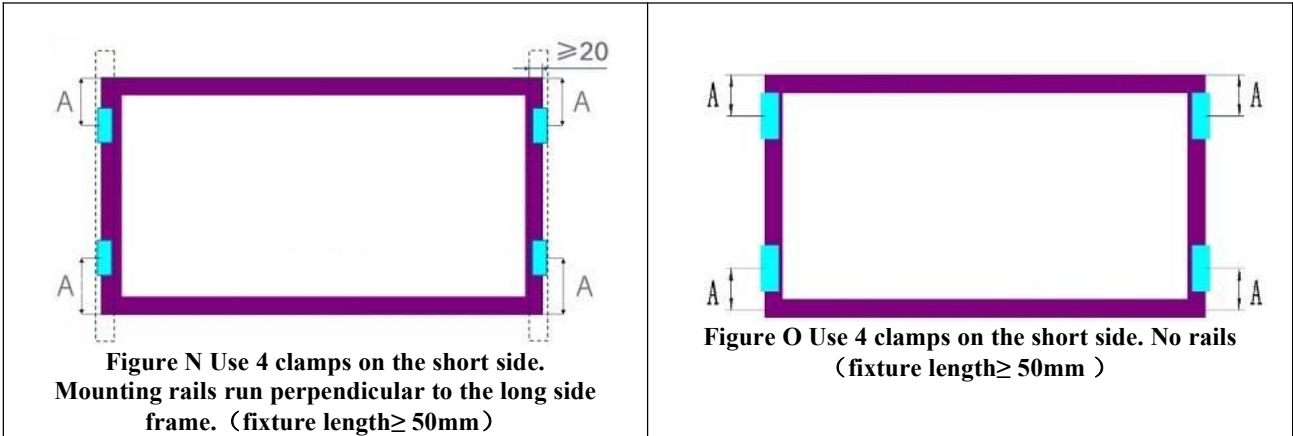

Figure 11 Schematic of different installation methods of bifacial dual glass products

Installation method Module type	Screw installation		Clamp installation	
	Figure J	Figure K	Figure L	Figure M
UL-***M-108ADGN(***=430-440W)	+5400 -2400	+3600 -2400	+5400 -2400	+3600 -2400
UL-***M-108BDGN(***=440-460W)				
UL-***M-108CDGN(***=450-485W)				
UL-***M-120BDGN(***=490-510W)				
UL-***M-144ADGN(***=565-590W)				
UL-***M-156ADGN(***=590-625W)				
UL-***M-144CDGN(***=600-640W)				
UL-***M-132DG(***=650-670W)			Not recommended	Not recommended
UL-***M-132DGN(***=690-715W)				



Snow load and wind load of simple support system



Load capacities of different simple installation modes:

Module type \ Installation method	Figure N	Figure O
UL-***M-108ADGN(***=430-440W)	+1800 -1800 (A=150~250mm)	+1200 -1200 (A=0~250mm)
UL-***M-108BDGN(***=440-460W)		
UL-***M-108CDGN(***=450-485W)		+900 -450 (A=0~250mm)
UL-***M-120BDGN(***=490-510W)		
UL-***M-144ADGN(***=565-590W)	Not recommended	Not recommended
UL-***M-156ADGN(***=590-625W)		
UL-***M-144CDGN(***=600-640W)		
UL-***M-132DG(***=650-670W)		
UL-***M-132DGN(***=690-715W)		

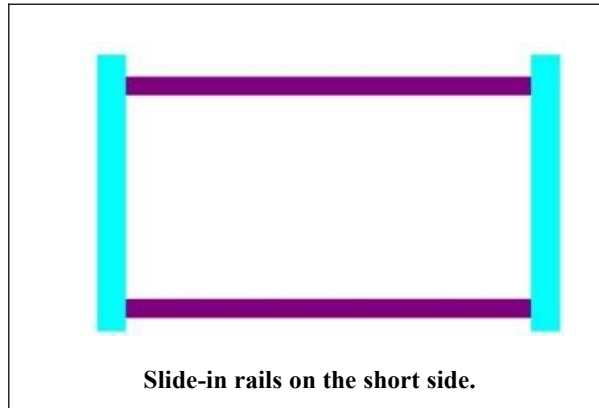

Load capacities of different simple installation modes:

Installation method Module type	Slide-in rails on the short side
UL-***M-108ADGN(***=430-440W)	+2200 -1600
UL-***M-108BDGN(***=440-460W)	
UL-***M-108CDGN(***=450-485W)	
UL-***M-120BDGN(***=490-510W)	+1000 -1000
UL-***M-144ADGN(***=565-590W)	
UL-***M-156ADGN(***=590-625W)	
UL-***M-144CDGN(***=600-640W)	Not recommended
UL-***M-132DGN(***=690-715W)	
UL-***M-132DG(***=650-670W)	

The above installation methods are simple installation mode, these installation modes are not Ulica Solar’s recommended installation method. The advantages of simple installation methods are convenient installation and low installation cost. The disadvantage is that after installation, the anti-snow load capacity of the module is weak, which can easily lead to modules fragmentation. It is not recommended to use them in areas with snow cover greater than 0.5 meters. The installation method of clamps only on the short side can easily cause slight bending and sagging of the aluminum frame due to the large span of the module. Customers who are concerned about this phenomenon are prohibited from using this installation method. Add a guide rail in the middle of the long edge of the module, so that the middle of the module does not significantly.

4.4 GROUNDING

- All module frames and mounting racks must be properly grounded in accordance with the electrical design and construction specifications, procedures, regulations and other special grounding requirements applicable to the installation sites.
- Proper grounding can be achieved by connecting the module frame(s) and all metallic structural components together by using a suitable grounding conductor. The grounding conductors or wires may be copper, alloy, or any other materials that are in accordance with the local electrical design and construction specifications, procedures, and regulations. The ground conductor must be reliably grounded by a suitable ground electrode.
- General grounding hardware comes in a package that includes the grounding screw, flat washer, star washer and wire and other relevant hardware should be made of stainless steel.
- Do not drill any extra ground holes for convenience, the Ulica Solar limited warranty will be voided.
- Ulica Solar does not provide grounding devices or materials. Any third-party grounding device that meets the requirements of the installation electrical equipment specifications can be used for grounding of Ulica Solar's modules. The grounding device should be installed in accordance with the operating manual prescribed by the manufacturer.
- Ulica Sola recommends using grounding wires with resistances that are less than 1Ω .
- The electrical contact is made by penetrating the anodized coating of the aluminum frame, and tightening the mounting screw (together with the star washer) to the proper torque of $3-7\text{ N}\cdot\text{m}$.
- Grounding connections should be installed by a qualified electrician. Connect module frames together using adequate grounding cables: Grounding wire size (4mm^2 solid bare copper) should be selected and installed underneath the wire binding bolt. Holes provided for this purpose are identified with a grounding symbol \perp (IEC61730-1). All conductive connection junctions must be firmly fixed.
- To avoid lightning strikes and ensure electrical safety, the module frames must be reliably grounded. Grounding between modules can be done using a 4mm^2 solid bare copper that connects adjacent ground holes on the module frame (unused installation holes on the frame can also be used for grounding).

Ulica Solar recommends using the following methods for grounding installation, as shown in Figure 12

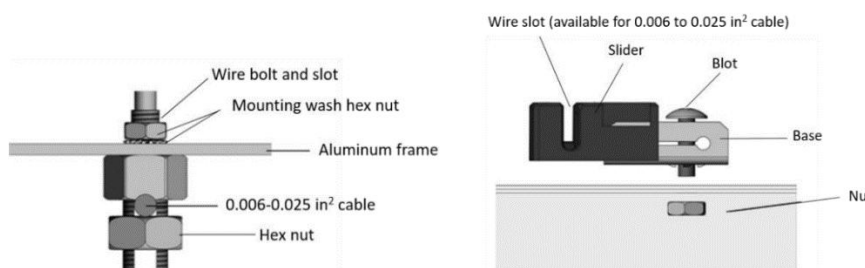

Figure 12. PV module grounding methods (IEC standard)

4.5 ELECTRICAL INSTALLATION

4.5.1 SAFETY INSTRUCTION

- All wiring installation should be carried out by qualified installers in accordance with local electrical construction codes, procedures, and regulations.
- Modules can be connected in series to increase the operating voltage by connecting the positive terminal of one module into the negative terminal of the next one. Before connecting, always ensure that the contacts are corrosion-free, clean, and dry.
- The product can be irreparably damaged if an array string is connected in reverse polarity to another. Always verify the voltage and polarity of each string before making a parallel connection. If a reversed polarity or a difference of more than 10V between strings was detected, check the string configuration before connection.
- The standard copper cables applied in Ulica Solar modules are UV resistant and with cross sectional area of $\geq 4\text{mm}^2$. All other cables applied to connect the DC system should be provided with a similar or larger wire cross section. Ulica Solar recommends that all cables are routed in appropriate conduits or rails where water does not accumulate.
- The string voltage must not be higher than the maximum system voltage, as well as the maximum input voltage of the inverter and the other electrical devices installed in the system. In order to ensure this, the open-circuit voltage of an array needs to be calculated at the lowest expected local ambient temperature, which can be determined using the following formula:

$$\text{Max System Voltage} \geq N \times V_{oc} \times [1 + TC_{voc} \times (T_{min} - 25)]$$

Where

N Number of modules in series

V_{oc} Open-circuit voltage (refer to product label or data sheet)

TC_{voc} Temperature coefficient of open-circuit voltage (refer to data sheet)

T_{min} The minimum ambient temperature

- The number of modules that can be connected shall be determined by a qualified institution or person in accordance with the design specifications of the photovoltaic system and the local electrical design specifications. The calculation formula recommended by Ulica Solar shall be for reference only.
- Recommended maximum series is $[1500\text{V}/(1.25 \times V_{oc})]$, parallel module configurations are $[\text{fuse rating}/I_{sc} \times 1.25]$.
- Every module is provided with two standard output cables, and each terminated with a plug-and-play connector. All wiring and electrical connections must be installed in accordance with the electrical design and construction specifications, procedures and regulations at the place of installation.

- The minimum and maximum outer diameters of the cable are 5 to 7mm (0.20 to 0.28 in).

- For wiring connections, please use standard PV copper wires with a cross-section area of at least 4mm², and should be light-resistant and temperature-resistant at a minimum of 90°C.
- When installing modules flat on the roof, it is recommended to use 4~6mm² PV-specific cables.



Do not bend the cables less than 43 mm (1.69inch) radius. PV cables will be damaged if bending radius less than 43 mm.



Figure 13. The correct routing and minimum bending radius of cables

4.5.2 WIRING

- In order to ensure the normal operation of the system, when connecting the module or loads (such as inverters, solar cells, etc.), observe to ensure that the polarity of the cable is connected correctly. If modules are not connected correctly, the bypass diode could be damaged. PV modules can be connected in series to increase the voltage and connected in parallel to increase the current.
- Before connecting the module, please make sure using the connector approved by Ulica Solar. Otherwise, Ulica Solar does not responsible for any potential problem.



- When conducting electrical connection of the modules, please use diagonal pliers to cut the cable tie. When cutting the tie, be careful not to scratch the cable and backsheet. According to the electrical requirements. The positive and negative connectors should be connected in turn, and confirm that you hear a "click" to indicate that the connection is successful. Otherwise, during the operation of the modules, this could lead to electric arc due to poor connections and can burn the connectors. Before the commissioning and operation of the power station, it is necessary to conduct electrical inspection on the modules and strings to confirm that the polarity of the strings is correct and that the open-circuit voltage meets the requirements of the acceptance specification.
- The number of modules in series and in parallel shall be designed reasonably according to the system configuration.

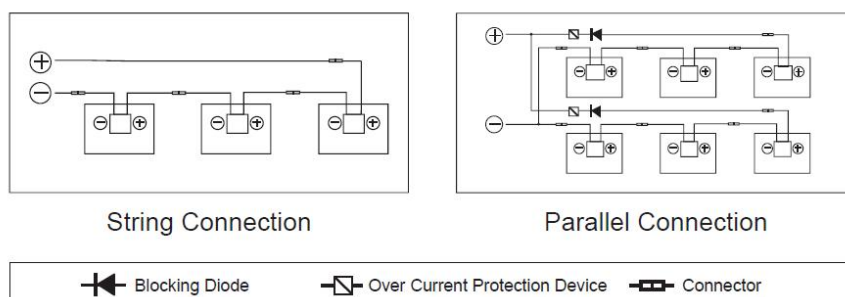

Portrait installation: Standard line length (Note: One end of the single row needs to be extended)

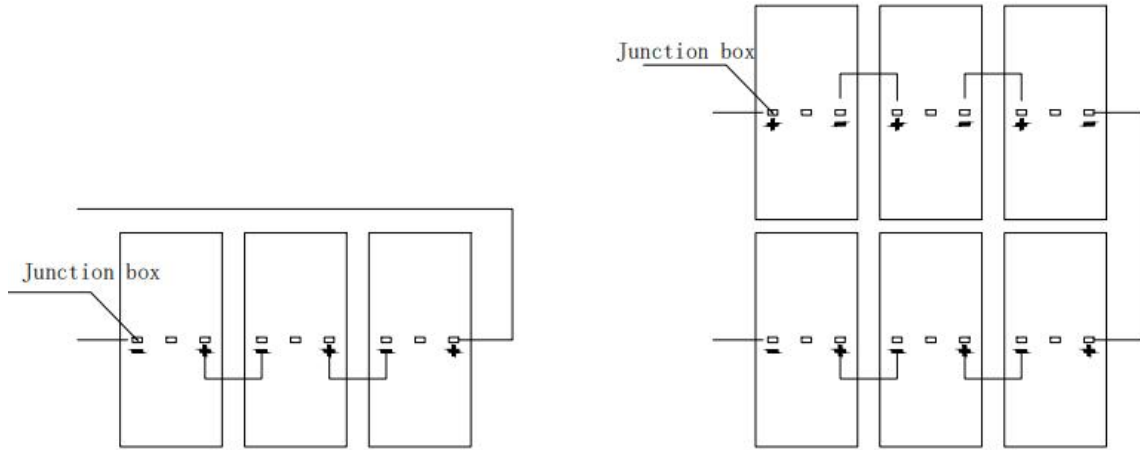

Landscape installation: The length of a single cable for a module with 120 cells must be $\geq 1.2\text{m}$, that for a module with 144 cells must be $\geq 1.4\text{m}$, and that for a module with 156 cells must be $\geq 1.5\text{m}$.

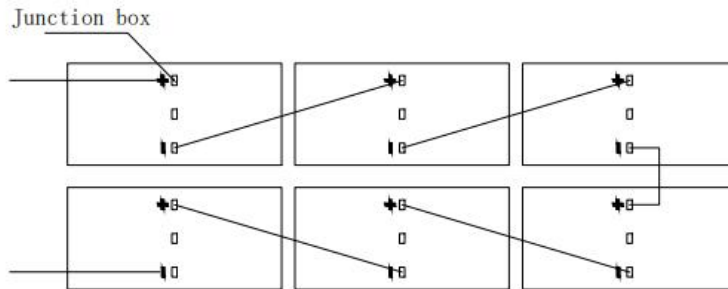

Figure 14. Circuit diagram for series connections and parallel connections & Reference for module connections

4.5.3 FUSING

- The correction factor of a fuse shall be determined by an authorized professional electrical engineer in accordance with the relevant design regulations and system simulation results. Ulica Solar does not responsible for determining the minimum rating of fuse.
- The fuse rated current should be chosen depending on different standards, as follows:

$$\frac{1.5}{K_f} \cdot I_{SC} \leq I_n \leq \text{Max Series Fuse Rating (IEC standard)}$$

$$\frac{1.56}{K_f} \cdot I_{SC} \leq I_n \leq \text{Max Series Fuse Rating (NEC standard)}$$

Where

I_n : Fuse rated current [A]

I_{SC} : Short-circuit current of the module [A]

K_f : Temperature correction factor [-]

A correction factor (K_f) should be applied for determining the fuse rated current working at different temperatures. Please confirm the final fuse selection with the qualified design institutes and fuse manufacturer. The maximum series fuse rating value on the products' datasheet provided by Ulica Solar should be used for reference only.

5 PV MODULE MAINTENANCE

5.1 VISUAL INSPECTION AND REPLACEMENT

- The modules must be inspected and maintained regularly, which is the responsibility of the users. The circuit breaker should be disconnected before the inspection. If the modules are damaged, such as broken glass, broken cables, and damaged junction boxes, it may cause functional and safety failures. If the module is damaged, replace the damaged module with a new module of the same type. Do not touch the live part of the cable or connector.
- It is recommended to perform a preventive inspection every six months, and do not replace components of modules without authorization. If electrical or mechanical performance inspection or maintenance is required, it is recommended that qualified professionals should perform the operation to avoid electric shock or personal injury.
- The vegetation should be cut regularly to avoid shading and thus affecting the module's performance.
- Check if the mounting hardware is tightened correctly in place.
- Check whether all string fuses in each non-grounded pole are working properly.
- Please cover the front surface of modules with an opaque material during repairing. Modules exposed to sunlight can generate high voltage, which is extremely dangerous.
- Ulica Solar PV modules are equipped with bypass diodes in the junction box to minimize module heating and current losses.



- Before cleaning, make sure to wear PPE, such as insulated protective gloves, protective glasses, hard hats, safety insulated shoes, etc.
- When using scaffolding, it should be ensured that it is in a stable position or has anti-dumping measures. Installer should wear safety belts in accordance with local building codes.
- Do not stand on modules or brackets for cleaning work.
- Do not try to open the junction box to replace diodes, even if they fail.
- If the module is damaged (broken glass or scratches on the back sheet), it needs to be replaced.
- When performing special installations, it is necessary to wear cut-resistant gloves and other personal protective equipment.
- Before attempting to remove modules, be sure to isolate the impacted array string to prevent current generation.

- Use the relevant disconnect tool provided by the supplier to disconnect the connector of the affected module.

- Check the open-circuit voltage of the array string and verify that the open-circuit voltage of other strings connected in parallel are within a range of 10V difference.
- Turn the circuit breaker on again after checking.
- Please pay attention to the other safety precautions listed at the beginning of this manual.

5.2 CONNECTOR AND CABLE INSPECTION

- The following preventive maintenance checks are recommended to be performed every 6 months:
- Check the sealant of the junction box to ensure there are no cracks or gaps.
- Check all connectors for tight connections and corrosion; check all aspects of connectors, bolt torque, and grounding; check that mounted hardware is tightened in place, loose connections will cause damage to array.
- Check all cables for rodent damage or material deterioration to verify the connections. In addition, cables should be protected from direct sunlight and kept away from areas with accumulated water.

5.3 CLEANING

5.3.1 CAUTION

This manual covers the requirements for the cleaning procedures of Ulica Solar PV modules. Professional installers should read these guidelines carefully and strictly follow these instructions. Failure to follow these instructions may result in death, injury, or property damage. Damages induced by inappropriate cleaning procedures will void Ulica Solar limited warranty. The amount of electricity generated by a solar module is proportional to the amount of light captured. A module with shaded cells generated less energy, and therefore, it is essential to keep PV modules clean. The dirt such as bird droppings, leaves, dust is usually need to be cleaned.

- Do not clean the modules during the hottest time of the day to avoid thermal stress on the modules.
When cleaning the modules, make sure that the temperature difference between the water and the module is in the range of -5°C to 10°C.
- Use a dry or wet, soft and clean cloth, sponge, or soft bristled brush to wipe the PV module. Please make sure that the cleaning tools do not wear out glass, EPDM, silicon, aluminum alloys or steel.
- If there is greasy dirt or other substances which are difficult to clean, conventional household glass cleaning agents can be used. Pay attention not to use alkaline and strong acidic solvents, including hydrofluoric acid, alkali, acetone.
- For modules that are installed horizontally (0° tilt angle), they should be cleaned more frequently, as they do not have "self-cleaning" function as those installed at 10° or larger tilt angles.

- The back surface of the monofacial module usually does not need to be cleaned. When cleaning the back of the bifacial module, avoid any sharp objects that may cause damage or penetrate the base material. The other cleaning requirements are the same as the front-side.
- Cleaning activities create risk of damaging the modules and array components, as well as increasing the potential electric shock hazard.
- Cracked or broken modules represent an electric shock hazard due to leakage currents, and the risk of shock is increased when modules are wet. Before cleaning, thoroughly inspect modules for cracks, damage, and loose connections.
- During the daylight, the voltage and current present in the array are sufficient to cause a fatal electric shock.
- Please make sure that the array has been disconnected from other active components before starting the cleaning.
- Wear suitable protective clothing (clothes, insulating gloves, etc.) when cleaning the modules.
- Do not immerse the module, partially or totally, in water or any other cleaning solutions.
- Do not use such as lubricants and organic solvents to clean the connectors.
- Do not clean modules under the weather conditions of wind more than 4 class (in Beaufort scale), heavy rain or heavy snow.
- When cleaning the modules, it is forbidden to step on the modules, forbidden the injection of water to the backside of the modules or cables. Please ensure that the connectors are clean and dry to prevent electric shock and fire hazards.
- Do not use steam cleaner.

5.3.2 CLEANING METHODS

Methods A: Compressed water

Requirement for water quality:

①PH:6~8; ②Water hardness-Calcium carbonate concentration : ≤ 600 mg/L; ③Recommend to use soft water to wash; ④The recommended maximum water pressure is 4MPa (40 bar).

Method B: Compressed air

Ulica Solar recommends using this method to clean the soft dirt (like dust) on modules. This technique can be applied as long as the method is efficient enough to clean the modules considering the on-site conditions.

Method C: Wet cleaning

- If excessive soiling is present on the module surface, a non-conductive brush, sponge, or other mild agitating method may be used with caution.

- Please make sure that any brushes or agitating tools are constructed with non-conductive materials to minimize risk of electric shock and that they are not abrasive to the glass or the aluminum frame.
- If grease is present, an environmentally friendly cleaning agent may be used with caution.

Method D: Cleaning robot

If a cleaning robot is used for dry cleaning, the brush material is required to be soft plastic material, and the glass surface and aluminum alloy frame of the module will not be scratched during the cleaning process and after cleaning. The weight of the cleaning robot should not be too large. If the cleaning robot is improperly used, and the resulting module damage and power attenuation are not covered by Ulica Solar's warranty.

5.4 WEEDING

- This manual contains recommendations for weeding operation and maintenance of photovoltaic power station. The following measures can be taken to a certain extent to avoid and prevent the problem of module damage caused by stone splashing during weeding. System users and professional operation and maintenance personnel should read carefully. Ulica Solar warranty will be invalid if the module or glass is damaged by any external force.
- When the height of vegetation does not affect the normal operation and maintenance of the module, weeding can't be carried out.
- The use of scythe manually instead of weeding machine weeding, or the use of professional weeding equipment with protective devices can reduce the probability of stone splash to a certain extent.

5.5 TROUBLE SHOOTING

- If your PV system does not work normally after installation, please inform your installer immediately. It is recommended to perform preventive inspections every six months, and do not change the components of the modules without authorization.
- If electrical or mechanical performance inspection or maintenance is required, they should be operated by qualified professionals to avoid any electric shock or personal injury.

6 REPORTING TECHNICAL ISSUES AND CLAIMS

- Contact your installer.
- Please connect Ulica Solar's customer service team at sales@ulsolar.com.cn.
- For module specifications or datasheets, please download from: <http://www.ulicasolar.com/>.

