



MIN 2500TL-XH
MIN 3000TL-XH
MIN 3600TL-XH
MIN 4200TL-XH
MIN 4600TL-XH
MIN 5000TL-XH
MIN 6000TL-XH

Installation & Operation Manual



Download
Manual



Growatt New Energy

Shenzhen Growatt New Energy CO.,LTD
No.28 Guangming Road, Shiyan Street, Bao'an District,
Shenzhen, P.R.China

T +86 0755 2747 1942

E service@ginverter.com

W www.ginverter.com

GR-UM-171-A-02

Index

1 Notes on this manual

- 1.1 Validity
- 1.2 Target group
- 1.3 Additional information
- 1.4 Symbols in this document
- 1.5 Glossary

2 Safety

- 2.1 Intended use
- 2.2 Qualification of skilled person
- 2.3 Safety instruction
- 2.4 Assembly warnings
- 2.5 Electrical connection warnings
- 2.6 Operation warnings

3 Product introduction

- 3.1 TL-XH overview
- 3.2 Type label
- 3.3 Size and weight
- 3.4 Storage of inverter
- 3.5 The advantage of the unit

4 Unpacking and inspection

5 Installation

- 5.1 Safety instructions
- 5.2 Selecting the installation location
- 5.3 Mounting the inverter

6 Electrical connection

- 6.1 Safety
- 6.2 Wiring AC output
- 6.3 Connecting the second protective conductor
- 6.4 Connecting the PV array
- 6.5 Connecting the Battery
- 6.6 Connecting signal cable
- 6.7 Grounding the inverter
- 6.8 Active power control with smart meter ,ripple control signal receiver
- 6.9 Connecting the COM port
- 6.10 Electric arc hazards

7 Commissioning

- 7.1 Start the inverter
- 7.2 General setting
- 7.3 Advanced setting
- 7.4 Communication interfaces

8 Startup and shutdown the inverter

- 8.1 Startup the inverter
- 8.2 Shutdown the inverter

9 Maintenance and cleaning

- 9.1 Checking heat dissipation
- 9.2 Cleaning the inverter
- 9.3 Checking the DC disconnect

10 EU Declaration of conformity

11 Trouble shooting

- 11.1 Error messages displayed on OLED
- 11.2 System fault
- 11.3 Inverter warning
- 11.4 Inverter fault

12 Manufacturer warranty

13 Decommissioning

- 13.1 Dismantling the inverter
- 13.2 Packing the inverter
- 13.3 Storing the inverter
- 13.4 Disposing of the inverter

14 Technical data

- 14.1 Specification
- 14.2 PV & BAT & AC connectors info
- 14.3 Torque
- 14.4 Accessories

15 Compliance certificates

16 Contact

1 Notes on this manual

1.1 Validity

This manual describes the assembly, installation, commissioning and maintenance of the following Growatt Inverter model:

MIN 2500 TL-XH
 MIN 3000 TL-XH
 MIN 3600 TL-XH
 MIN 4200 TL-XH
 MIN 4600 TL-XH
 MIN 5000 TL-XH
 MIN 6000 TL-XH

This manual does not cover any details concerning equipment connected to the MIN TL-XH(e.g. PV modules). Information concerning the connected equipment is available from the manufacturer of the equipment.

1.2 Target Group

This manual is for qualified personnel. Qualified personnel have received training and have demonstrated skills and knowledge in the construction and operation of this device. Qualified Personnel are trained to deal with the dangers and hazards involved in installing electric devices.



1.3 Additional information



Find further information on special topics in the download area at www.ginverter.com
 The manual and other documents must be stored in a convenient place and be available at all times. We assume no liability for any damage caused by failure to observe these instructions. For possible changes in this manual, Shenzhen Growatt New Energy CO.,LTD accepts no responsibilities to inform the users.

1.4 Symbols in this document











1.4.1 Warnings in this document

A warning describes a hazard to equipment or personnel. It calls attention to a procedure or practice, which, if not correctly performed or adhered to, could result in damage to or destruction of part or all of the Growatt equipment and/or other equipment connected to the Growatt equipment or personal injury.

Symbol	description
 DANGER	DANGER indicates a hazardous situation which, if not avoided, will result in death or serious injury.
 WARNING	WARNING indicates a hazardous situation which, if not avoided, could result in death or serious injury.
 CAUTION	CAUTION indicates a hazardous situation which, if not avoided, could result in minor or moderate injury.

 NOTICE	NOTICE is used to address practices not related to personal injury.
 Information	Information that you must read and know to ensure optimal operation of the system.

1.4.2 Markings on this product

Symbol	Explanation
	Electrical voltage!
	Risk of fire or explosion !
	Risk of burns
	Wait for 5minutes before engaging in the indicated action.
	Point of connection for grounding protection
	Direct Current (DC)
	Alternating Current (AC)
	The inverter has no transformer.
	Read the manual
	CE mark. The inverter complies with the requirements of the applicable CE guidelines.
	Discard this product according to local regulations.

1.5 Glossary

AC
Abbreviation for "Alternating Current"

DC
Abbreviation for "Direct Current"

Energy
Energy is measured in Wh (watt hours), kWh (kilowatt hours) or MWh (megawatt hours). The energy is the power calculated over time. For example, your inverter operates at a constant power of 4600 W for half an hour and then at a constant power of 2300 W for another half an hour, it has fed 3450Wh of energy into the power distribution grid within that hour.

Power
Power is measured in W (watts), kW (kilowatts) or MW (megawatts). Power is an instantaneous value. It displays the power your inverter is currently feeding into the power distribution grid.

Power rate
Power rate is the ratio of current power feeding into the power distribution grid and the maximum power of the inverter that can feed into the power distribution grid.

Power factor
Power factor is the ratio of true power or watts to apparent power or volt amps. They are identical only when current and voltage are in phase than the power factor is 1.0. The power in an ac circuit is very seldom equal to the direct product of the volts and amperes. In order to find the power of a single phase ac circuit the product of volts and amperes must be multiplied by the power factor.

PV
Abbreviation for photovoltaic.

Wireless communication
The external wireless communication technology is a radio technology that allows the inverter and other communication products to communicate with each other. The external wireless communication does not require line of sight between the devices and it is selective purchasing.

2 Safety

2.1 Intended Use

The unit converts the DC current generated by the photovoltaic (PV) modules to grid-compliant alternating current and performs single-phase feed-in into the electricity grid. MIN 2500TL-XH, MIN 3000TL-XH, MIN 3600TL-XH, MIN 4200TL-XH, MIN 4600TL-XH, MIN 5000TL-XH, MIN 6000TL-XH inverters are built according to all required safety rules. Nevertheless, improper use may cause lethal hazards for the operator or third parties, or may result in damage to the units and other property.

Principle of a PV plant with this MIN TL-XH single-phase inverter

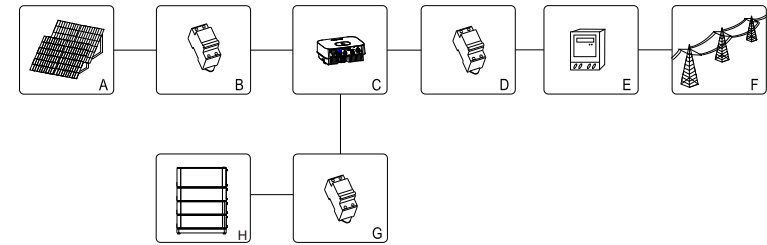

Position	Description
A	PV modules
B*	DC load circuit breaker
C	Inverter
D	AC load circuit breaker
E	Energy meter
F	Utility grid
G	DC load circuit breaker
H	Battery matched with XH inverter

* According to local regulations or installation requirements to choose DC isolator or DC load circuit breaker.

The inverter may only be operated with a permanent connection to the public power grid. The inverter is not intended for mobile use. Any other or additional use is not considered the intended use. The manufacturer/supplier is not liable for damage caused by such unintended use. Damage caused by such unintended use is at the sole risk of the operator.

PV modules Capacitive Discharge Currents
PV modules with large capacities relative to earth, such as thin-film PV modules with cells on a metallic substrate, may only be used if their coupling capacity does not exceed 1µF. During feed-in operation, a leakage current flows from the cells to earth, the size of which depends on the manner in which the PV modules are installed (e.g. foil on metal roof) and on the weather (rain, snow). This "normal" leakage current may not exceed 50mA due to the fact that the inverter would otherwise automatically disconnect from the electricity grid as a protective measure.



2.2 Qualification of skilled person

This inverter system operates only when properly connected to the AC distribution network. Before connecting the MIN TL-XH to the power distribution grid, contact the local power distribution grid company. This connection must be made only by qualified technical personnel to connect, and only after receiving appropriate approvals, as required by the local authority having jurisdiction.

2.3 Safety instruction

The MIN TL-XH Inverters is designed and tested according to international safety requirements (IEC62109-1,CE,VDE-AR-N4105,CEI0-21,VDE0126-1-1, AS4777,ect.) ; however, certain safety precautions must be observed when installing and operating this inverter. Read and follow all instructions, cautions and warnings in this installation manual. If questions arise, please contact Growatt's technical services at +86 (0)755 2747 1942.

2.4 Assembly Warnings



 WARNING	<ul style="list-style-type: none"> ➤ Prior to installation, inspect the unit to ensure absence of any transport or handling damage, which could affect insulation integrity or safety clearances; failure to do so could result in safety hazards. ➤ Assemble the inverter per the instructions in this manual. Use care when choosing installation location and adhere to specified cooling requirements. ➤ Unauthorized removal of necessary protections, improper use, incorrect installation and operation may lead to serious safety and shock hazards and/or equipment damage. ➤ In order to minimize the potential of a shock hazard due to hazardous voltages, cover the entire solar array with dark material prior to connecting the array to any equipment.
 CAUTION	<ul style="list-style-type: none"> ➤ Grounding the PV modules: The MIN TL-XH is a transformerless inverter. That is why it has no galvanic separation. Do not ground the DC circuits of the PV modules connected to the MIN TL-XH. Only ground the mounting frame of the PV modules.If you connect grounded PV modules to the MIN TL-XH, the error message "PV ISO Low". ➤ Comply with the local requirements for grounding the PV modules and the PV generator. GROWATT recommends connecting the generator frame and other electrically conductive surfaces in a manner which ensures continuous conduction with ground in order to have optimal protection of the system and personnel.

2.5 Electrical Connection Warnings

 DANGER	<ul style="list-style-type: none"> ➤ The components in the inverter are live. Touching live components can result in serious injury or death. <ul style="list-style-type: none"> • Do not open the inverter except the wire box by qualified persons. • Electrical installation, repairs and conversions may only be carried out by electrically qualified persons. • Do not touch damaged inverters. ➤ Danger to life due to high voltages in the inverter <ul style="list-style-type: none"> • There is residual voltage in the inverter. The inverter takes 20 minutes to discharge.
--	---

	<ul style="list-style-type: none"> ➤ Persons with limited physical or mental abilities may only work with the Growatt inverter following proper instruction and under constant supervision. Children are forbidden to play with the Growatt inverter. Must keep the Growatt inverter away from children.
 WARNING	<ul style="list-style-type: none"> ➤ Make all electrical connections (e.g. conductor termination, fuses, PE connection, etc.) in accordance with prevailing regulations. When working with the inverter powered on, adhere to all prevailing safety regulations to minimize risk of accidents. ➤ Systems with inverters typically require additional control (e.g., switches, disconnects) or protective devices (e.g., fusing circuit breakers) depending upon the prevailing safety rules.

2.6 Operation Warnings

 WARNING	<ul style="list-style-type: none"> ➤ Ensure all connectors are sealed and secure during operation. ➤ Although designed to meet all safety requirements, some parts and surfaces of Inverter are still hot during operation. To reduce the risk of injury, do not touch the heat sink at the back of the Inverter or nearby surfaces while Inverter is operating. ➤ Incorrect sizing of the PV plant may result in voltages being present which could destroy the inverter. The inverter display will read the error message "PV voltage High!" <ul style="list-style-type: none"> • Turn the rotary switch of the DC Disconnect to the Off position immediately. • Contact installer.
 CAUTION	<ul style="list-style-type: none"> ➤ All operations regarding transport, installation and start-up, including maintenance must be operated by qualified, trained personnel and in compliance with all prevailing codes and regulations. ➤ Anytime the inverter has been disconnected from the power network, use extreme caution as some components can retain charge sufficient to create a shock hazard; to minimize occurrence of such conditions, comply with all corresponding safety symbols and markings present on the unit and in this manual. ➤ In special cases, there may still be interference for the specified application area despite maintaining standardized emission limit values (e.g. when sensitive equipment is located at the setup location or when the setup location is near radio or television receivers).In this case, the operator is obliged to take proper action to rectify the situation. ➤ Do not stay closer than 20 cm to the inverter for any length of time.

3 Product description

3.1 TL-XH Overview

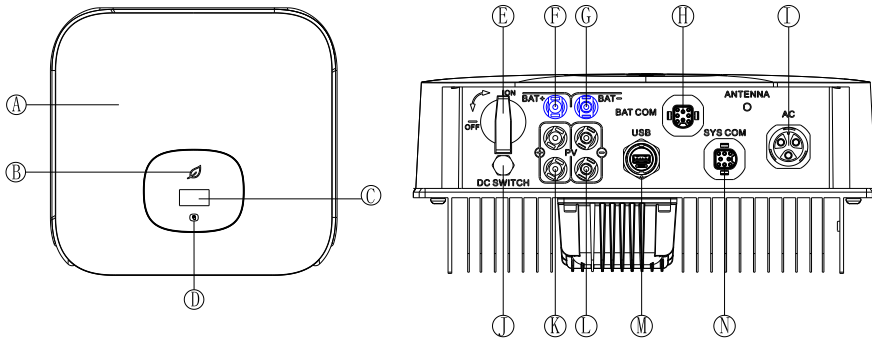





Position	Description	Position	Description
A	Cover	H	COM port
B	LED	I	AC output
C	OLED	J	Ventilation valve
D	Touch button	K	PV input +
E	DC switch	L	PV input -
F	Battery input+	M	USB port
G	Battery input-	N	SYS COM port

Symbol on the inverter

Symbol	Description	Explanation
	Touch symbol	Touch button. We can switch the OLED display and set parameter by touching.
	Inverter status symbol	Indicates inverter operation status: Red: Fault. Green: Normal. Red leaf flash: Warning or DSP Programming. Green leaf flash: M3 Programming or Battery warning.

3.2 Type label

The type labels provide a unique identification of the inverter (The type of product, Device-specific characteristics, Certificates and approvals). The type labels are on the left-hand side of the enclosure.

GROWATT Hybrid Inverter	
Model name	MIN 5000TL-XH
Max. PV voltage	550 d.c.V
PV voltage range	70-550 d.c.V
PV Isc	16.9 d.c.A*2
Max. input current	13.5 d.c.A*2
Max. DC voltage	550 d.c.V
DC voltage range	360-550 d.c.V
Max. DC current	17 d.c.A
Nominal input/output power	5000/5000 W
Max. apparent power	5000 VA
Nominal output voltage	230 a.c.V
Nominal input/output current	22.7/22.7 a.c.A
Nominal output Frequency	50/60 Hz
Power factor range	0.8leading~0.8lagging
Safety level	Class I
Ingress Protection	IP65
Operation Ambient Temperature	-25°C - +60°C
VDE0126-1-1  Type Approved Safety Regular Production Surveillance www.tuv.com ID 2000000000    Made in China	

More detail about the type label as the chart below:

Model Name	MIN 2500 TL-XH	MIN 3000 TL-XH	MIN 3600 TL-XH
Max input PV voltage	500V	500V	550V
Max input PV current	13.5A/13.5A		
Start voltage	100V		
MPP voltage range	70V~500V	70V~500V	70V~550V
DC nominal input voltage	380V		
DC input voltage range	350V~500V	350V~500V	350V~550V
DC Max input/output current	17A		
AC nominal voltage	230V		
AC grid frequency	50/60 Hz		
Max. apparent power	2500VA	3000VA	3600VA
Max AC output current	11.3A	13.6A	16A
Power factor	0.8leading...0.8lagging		
Environmental Protection Rating	IP 65		
Operation Ambient temperature	-25...+60°C (-13...+ 140°F) with derating above 45°C (113°F)		

Model Name	MIN 4200 TL-XH	MIN 4600 TL-XH	MIN 5000 TL-XH	MIN 6000 TL-XH
Max input PV voltage	550V			
Max input PV current	13.5A/13.5A			
Start voltage	100V			
MPP voltage range	70V~550V			
DC nominal input voltage	380V			
DC input voltage range	350V~550V			
DC Max input/output current	17A			
AC nominal voltage	230V			
AC grid frequency	50/60 Hz			
Max. apparent power	4200VA	4600VA	5000VA	6000VA
Max AC output current	19A	20.9A	22.7A	27.2A
Power factor	0.8leading...0.8lagging			
Environmental Protection Rating	IP 65			
Operation Ambient temperature	-25...+60°C (-13...+ 140°F) with derating above 45°C (113°F)			

3.3 Size and weight

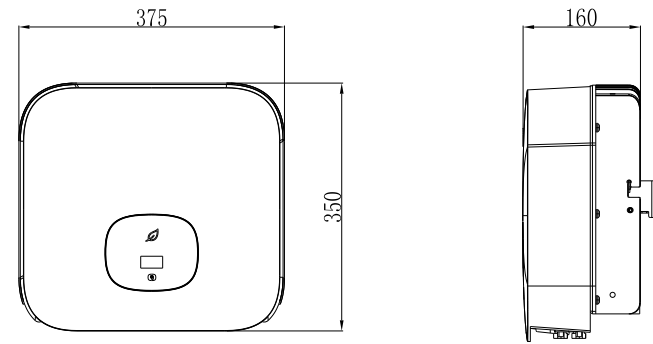

Dimensions and weight

Model	Height (H)	Width (W)	Depth (D)	Weight
MIN 2500-6000 TL-XH	350mm 13.8inch	375mm 14.8inch	160mm 6.3inch	10.8kg

3.4 Storage of Inverter

If you want to storage the inverter in your warehouse, you should choose an appropriate location to store the inverter.

- The unit must be stored in original package , and should be stored in a clean and dry place, and be protected from dust and water vapor corrosion.
- The storage temperature should be always between -25 and +60 . And the storage relative humidity can achieve to 100%.
- If there are a batch of inverters need to be stored, the maximum layers for original carton is four.
- After long term storage, local installer or service department of GROWATT should perform a comprehensive test before installation.

3.5 The advantage of the unit

- Max. efficiency of 98.4%
- Dual MPP trackers
- Type II SPD on DC side
- 30% lighter
- Storage ready
- AFCI optional
- Compatible with double-glass bifacial modules

4 Unpacking and inspection

The inverter is thoroughly tested and inspected strictly before delivery. Our inverters leave our factory in proper electrical and mechanical condition. Special packaging ensures safe and careful transportation. However, transport damage may still occur. The shipping company is responsible in such cases. Thoroughly inspect the inverter upon delivery. Immediately notify the responsible shipping company if you discover any damage to the packaging which indicates that the inverter may have been damaged or if you discover any visible damage to the inverter. We will be glad to assist you, if required. When transporting the inverter, the original or equivalent packaging should be used, and the maximum layers for original carton is four, as this ensures safe transport.

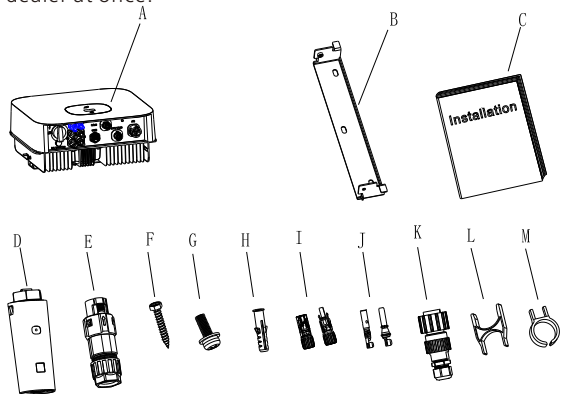

After opening the package, please check the contents of the box. It should contain the following. Please check all of the accessories carefully in the carton. If anything missing, contact your dealer at once.



Object	Description	Quantity
A	Inverter	1
B	Mounting bracket	1
C	Quick Guide	1
D	Monitor(Optional)	1
E	COM PORT Signal connector	1
	SYS COM PORT Signal connector	1
F	Self-tapping screws	3
G	Safety-lock screw	1
H	Plastic expansion pipe	3
I	PV+/PV- terminal	2/2
J	PV+/PV-metal terminal	2/2
K	AC connector	1
L	Uninstall signal or AC connector tool	1
M	Uninstall PV or Battery terminal tool	1

Installation 5

5.1 Safety instructions

	<p>Danger to life due to fire or explosion</p> <ul style="list-style-type: none"> ➤ Despite careful construction, electrical devices can cause fires. ➤ Do not install the inverter on easily flammable materials and where flammable materials are stored.
	<p>Risk of burns due to hot enclosure parts</p> <p>Mount the inverter in such a way that it cannot be touched inadvertently.</p>
	<p>Possible damage to health as a result of the effects of radiation!</p> <ul style="list-style-type: none"> ➤ In special cases, there may still be interference for the specified application area despite maintaining standardized emission limit values (e.g. when sensitive equipment is located at the setup location or when the setup location is near radio or television receivers). In this case, the operator is obliged to take proper action to rectify the situation. ➤ Never install the inverter near the sensitive equipment (e.g. Radios, telephone, television, etc) . ➤ Do not stay closer than 20 cm to the inverter for any length of time unless it is absolutely necessary. ➤ Growatt assumes no responsibility for compliance to EMC regulations for the complete system.

- All electrical installations shall be done in accordance with the local and national electrical codes. Do not remove the casing. Inverter contains no user serviceable parts. Refer servicing to qualified service personnel. all wiring and electrical installation should be conducted by a qualified service personnel .
- Carefully remove the unit from its packaging and inspect for external damage. If you find any imperfections, please contact your local dealer.
- Be sure that the inverters connect to the ground in order to protect property and personal safety.
- The inverter must only be operated with PV generator. Do not connect any other source of energy to it.
- Both AC and DC voltage sources are terminated inside the PV Inverter. Please disconnect these circuits before servicing.
- This unit is designed to feed power to the public power grid (utility) only. Do not connect this unit to an AC source or generator. Connecting Inverter to external devices could result in serious damage to your equipment.
- When a photovoltaic panel is exposed to light, it generates a DC voltage. When connected to this equipment, a photovoltaic panel will charge the DC link capacitors.
- Energy stored in this equipment's DC link capacitors presents a risk of electric shock. Even after the unit is disconnected from the grid and photovoltaic panels, high voltages may still exist inside the PV-Inverter. Do not remove the casing until at least 5 minutes after disconnecting all power sources.
- Although designed to meet all safety requirements, some parts and surfaces of Inverter are still hot during operation. To reduce the risk of injury, do not touch the heat sink at the back of the PV-Inverter or nearby surfaces while Inverter is operating.

5.2 Selecting the installation location

- This is guidance for installer to choose a suitable installation location, to avoid potential damages to device and operators.
- The installation location must be suitable for the inverter's weight and dimensions for a long period time.
- Select the installation location so that the status display can be easily viewed.
- Do not install the inverter on structures constructed of flammable or thermolabile materials.
- Never install the inverter in environment of little or no air flow, nor dust environment. That may derate the efficiency of the cooling fan of the inverter.
- The Ingress Protection rate is IP65 which means the inverter can be installed outdoors and indoors.
- The humidity of the installation location should be 0~100% without condensation.
- The installation location must be freely and safely to get at all times.
- Vertically installation and make sure the connection of inverter must be downwards. Never install horizontal and avoids forward and sideways tilt.

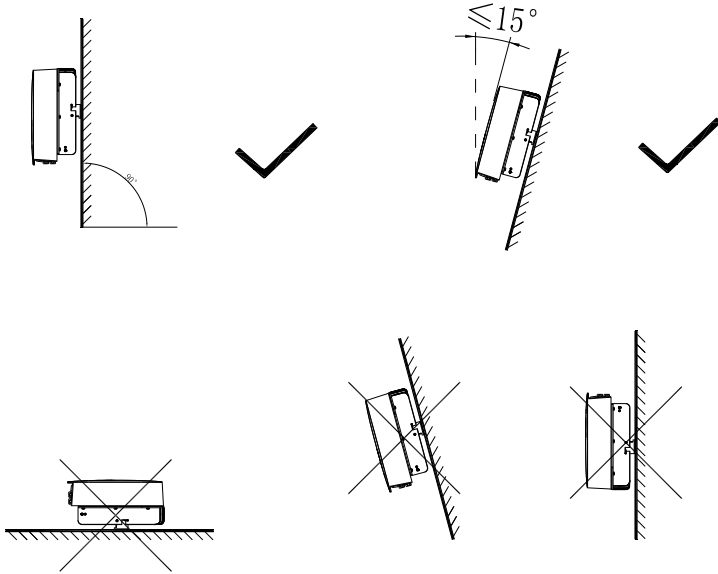

- Be sure that the inverter is out of the children's reach.
- Don't put any things on the inverter. Do not cover the inverter.
- Do not install the inverter near television antenna or any other antennas and antenna cables.
- Inverter requires adequate cooling space. Providing better ventilation for the inverter to ensure the heat escape adequately. The ambient temperature should be below 40°C to ensure optimum operation.
- Do not expose the inverter to direct sunlight, as this can cause excessive heating and thus power reduction.
- Observe the Min. clearances to walls, other inverters, or objects as shown below:

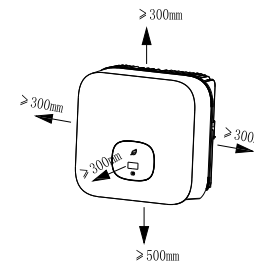

Ambient dimensions of **one inverter**

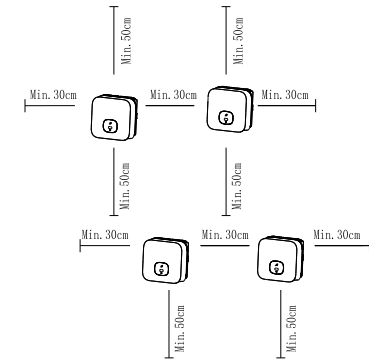

Ambient dimensions of **series inverters**

- There must be sufficient clearance between the individual inverters to ensure that the cooling air of the adjacent inverter is not taken in.
- If necessary, increase the clearance spaces and make sure there is enough fresh air supply to ensure sufficient cooling of the inverters.

The inverter can't install to solarization, drench, firm location. We suggest that the inverters should be installed at the location with some cover or protection.



- Please make sure the inverter is installed at the right place. The inverter can't install close to trunk.

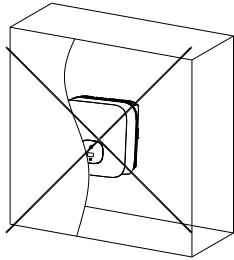

5.3 Mounting the Inverter

5.3.1 Mounting the Inverter with bracket



DANGER

In order to avoid electrical shock or other injury, inspect existing electronic or plumbing installations before drilling holes.

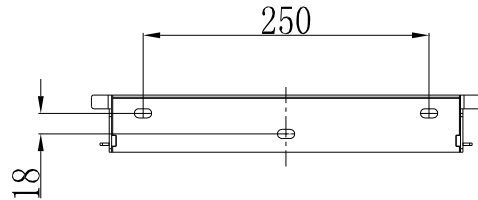

- Fix the mounting bracket as the figure shows. Do not make the screws to be flush to the wall. Instead, leave 2 to 4mm exposed.

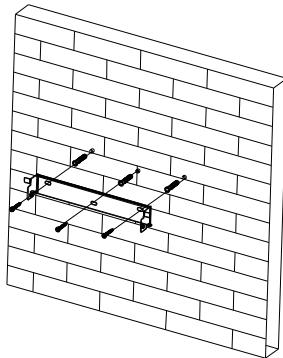

5.3.2 Fixed the inverter on the wall



WARNING

Falling equipment can cause serious or even fatal injury, never mount the inverter on the bracket unless you are sure that the mounting frame is really firmly mounted on the wall after carefully checking.

- Rise up the inverter a little higher than the bracket. Considered the weight of them. During the process please maintain the balance of the inverter.
Hang the inverter on the bracket through the match hooks on bracket.

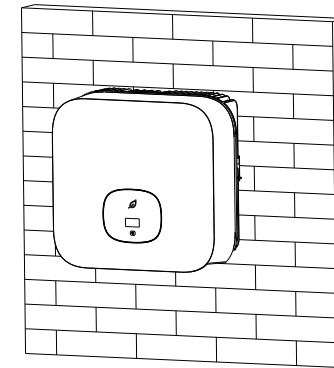

- After confirming the inverter is fixed reliably, fasten one M6 safety-lock sockets head cap screws on the right or left side firmly to prevent the inverter from being lifted off the bracket.

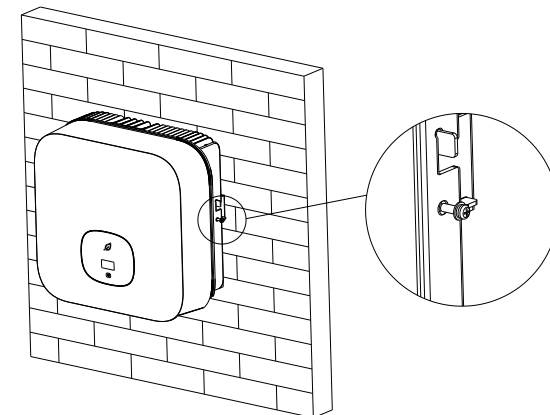



6 Electrical connection

Decisive Voltage Class (DVC) indicated for ports

Port Name	Class
AC Output	C
DC Input	C
COM&SYS COM Port	A
RS485&USB	A

6.1 Safety

	<p>Danger to life due to lethal voltages! High voltages which may cause electric shocks are present in the conductive parts of the inverter. Prior to performing any work on the inverter, disconnect the inverter on the AC and DC sides</p>
 WARNING	<p>Danger of damage to electronic components due to electrostatic discharge. Take appropriate ESD precautions when replacing and installing the inverter.</p>

6.2 Wiring AC Output

 WARNING	<p>➤ You must install a separate single-phase circuit-breaker or other load disconnection unit for each inverter in order to ensure that the inverter can be safely disconnected under load.</p> <p>NOTE : The inverter has the function of detecting residual current and protecting the inverter against residual current. If your inverter has to equip a AC breaker which has the function of detecting residual current ,you must choose a AC breaker with the rating residual current more than 300mA.</p>
--	---

You must install a separate single-phase circuit-breaker or other load disconnection unit for each inverter in order to ensure that the inverter can be safely disconnected under load.

We suggest you choice the AC breaker rating current in this table:

MIN 2500TL-XH	16A/230V
MIN 3000TL-XH	16A/230V
MIN 3600TL-XH	20A/230V
MIN 4200TL-XH	25A/230V
MIN 4600TL-XH	25A/230V
MIN 5000TL-XH	32A/230V
MIN 6000TL-XH	32A/230V

The AC wiring step:

1.Uninstall the parts of the AC connection plug from the accessory bag.

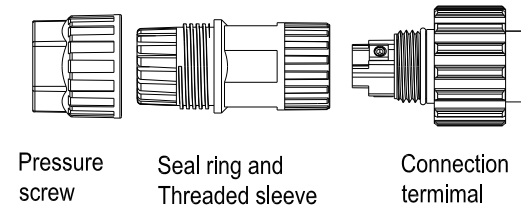

Pressure screw Seal ring and Threaded sleeve Connection terminal

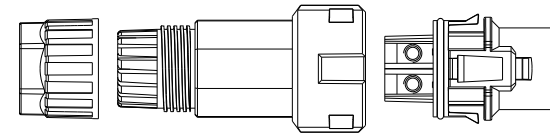

Pressure screw Seal ring and Threaded sleeve Connection terminal

2.Insert the stripped and bared cable through pressure screw, seal ring, threaded sleeve in sequence, insert cables into connection terminal according to polarities indicates on it and tighten the screws firmly. Please try to pull out the wire to make sure the it's well connected.

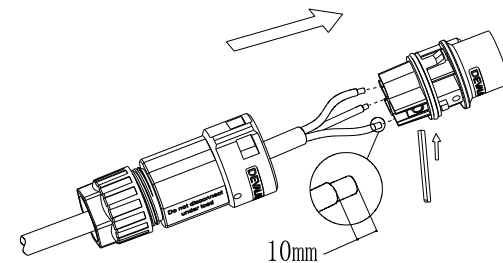
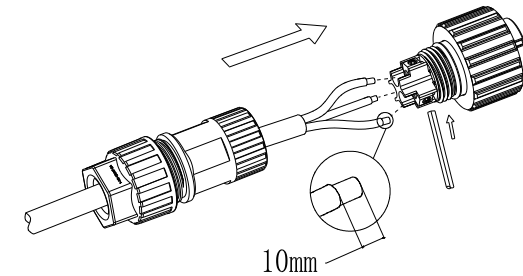

3. Push the threaded sleeve into the socket, Tighten up the cap on the terminal.

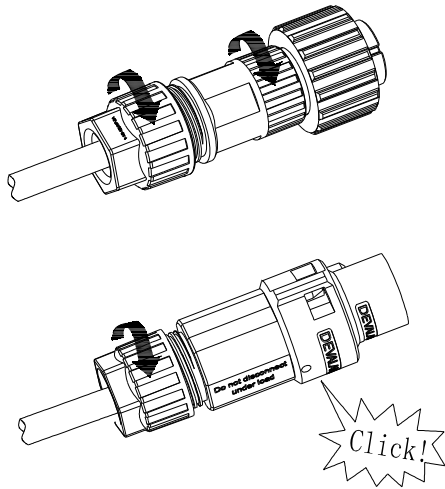

4. Finally, Push or screw the threaded sleeve to connection terminal until both are locked tightly on the inverter.

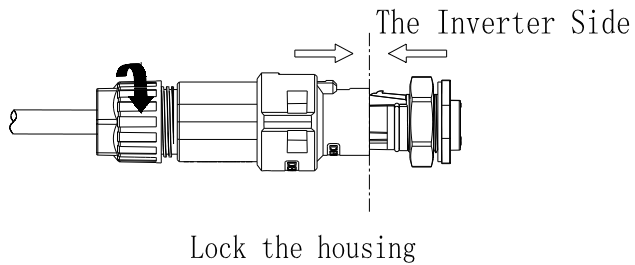
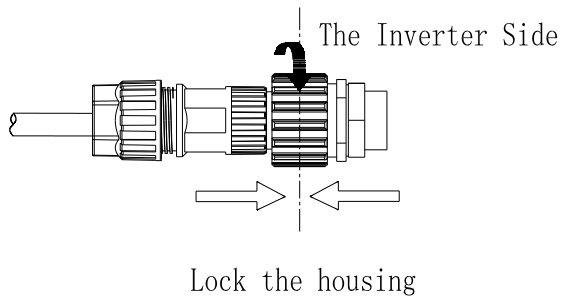

5. To remove the AC connector, press the bayonet out of the slot with a small screwdriver and pull it out, or unscrew the threaded sleeve, then pull it out.

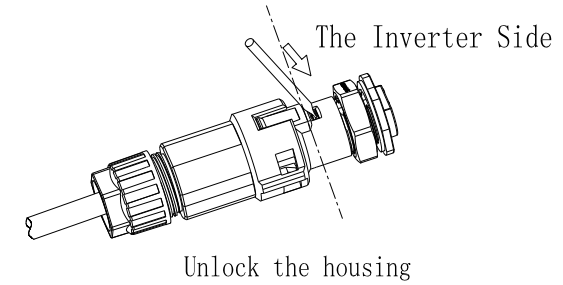
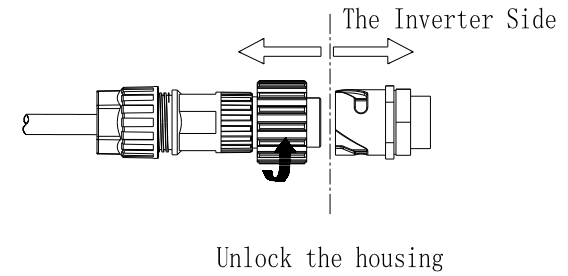

Wire suggestion length

Conductor cross section	Max. cable length		
	MIN 2500 TL-XH	MIN 3000 TL-XH	MIN 3600 TL-XH
4 mm ² 12AWG	48m	40m	33m
5.2 mm ² 10AWG	60m	50m	42m
Conductor cross section	Max. cable length		
	MIN 4200 TL-XH MIN 4600 TL-XH	MIN 5000 TL-XH	MIN 6000 TL-XH
5.2 mm ² 10AWG	28m	26m	24m

6.3 Connecting the second protective conductor

In some installation countries, a second protective conductor is required to prevent a touch current in the event of a malfunction in the original protective conductor. For installation countries falling within the scope of validity of the IEC standard 62109, you must install the protective conductor on the AC terminal with a conductor cross-section of at least 10 mm²Cu. Or install a second protective conductor on the earth terminal with the same cross-section as the original protective conductor on the AC terminal. This prevents touch current if the original protective conductor fails.

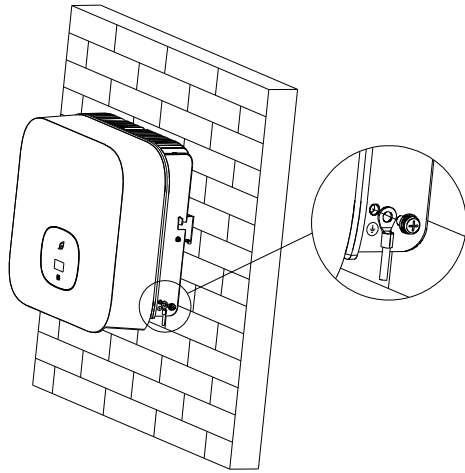

6.4 Connecting the PV Array

6.4.1 Conditions for PV Array

The MIN TL-XH single-phase inverter has 2 independent PV input : PV1 & PV2 . Notice that the connectors are in paired (male and female connectors). The connectors for PV arrays and inverters are Helios H4-R/VP-D4/MC4 connectors;

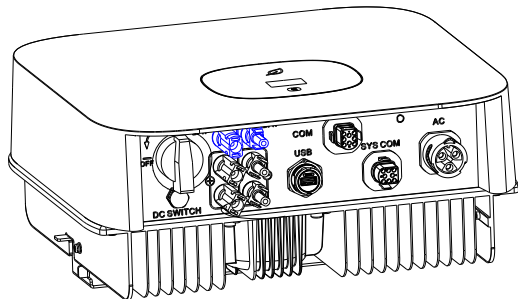



CAUTION

If the inverter is not equipped with a DC switch but this is mandatory in the country of installation, install an external DC switch. The following limit values at the DC input of the inverter must not be exceeded:

Types	Max current PV1	Max current PV2	Max voltage
2500-3000 TL-XH	13.5A	13.5A	500V
3600-6000 TL-XH	13.5A	13.5A	550V

It is suggesting that connecting eleven PV modules that have an IEC 61730 Class A rating in series as one PV input.

6.4.2 Connecting the PV Array



DANGER

Danger to life due to lethal voltages!

Before connecting the PV array, ensure that the DC switch and AC breaker are disconnect from the inverter. NEVER connect or disconnect the PV connectors under load. Make sure the maximum open circuit voltage(Voc) of each PV string is less than the maximum input voltage of the inverter. Check the design of the PV plant. The Max. open circuit voltage, which can occur at solar panels temperature of -10°C, must not exceed the Max. input voltage of the inverter.



WARNING

Improper operation during the wiring process can cause fatal injury to operator or unrecoverable damage to the inverter. Only qualified personnel can perform the wiring work. Please don't connect PV array positive or negative pole to the ground, it could cause serious damages to the inverter. Check the connection cables of the PV modules for correct polarity and make sure that the maximum input voltage of the inverter is not exceeded.

Connection of PV terminal

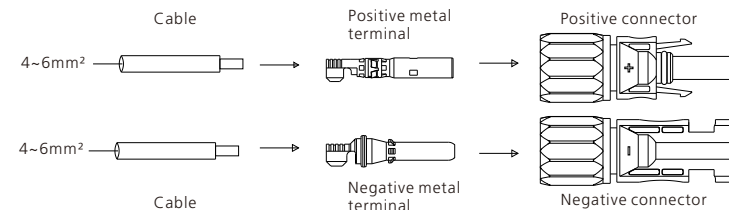

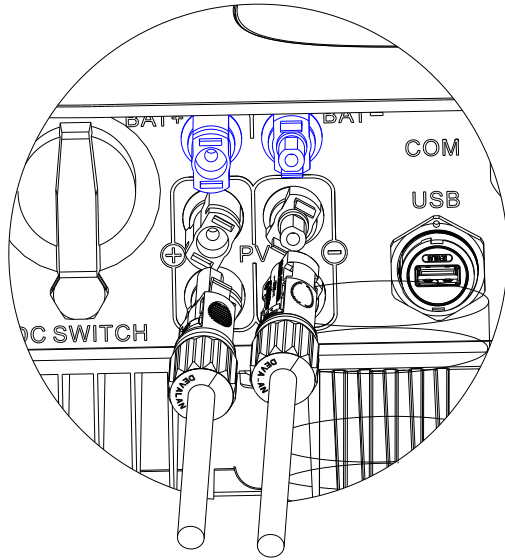



6.5 Connecting the Battery

6.5.1 Conditions for the Battery

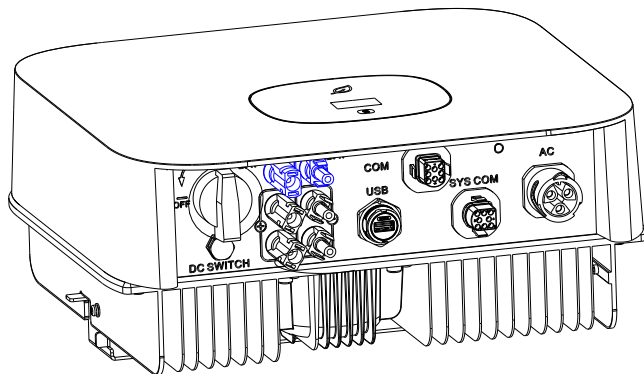
The MIN TL-XH single-phase inverter has one independent Battery input : BAT+/BAT- connecting to the output of the Battery.
 Notice that the connectors are in paired (male and female connectors). The connectors for the Battery and inverters are Helios H4-R/VP-D4/MC4 connectors;



6.5.2 Connecting the Battery

 DANGER	<p>Danger to life due to lethal voltages! Before connecting the Battery, ensure that it does not connect any power supply. NEVER connect or disconnect the Battery. Forbidden to reverse the positive and negative poles of the Battery and the inverter.</p>
 WARNING	<p>Improper operation during the wiring process can cause fatal injury to operator or unrecoverable damage to the inverter. Only qualified personnel can perform the wiring work.</p>

Connection of BAT input terminal

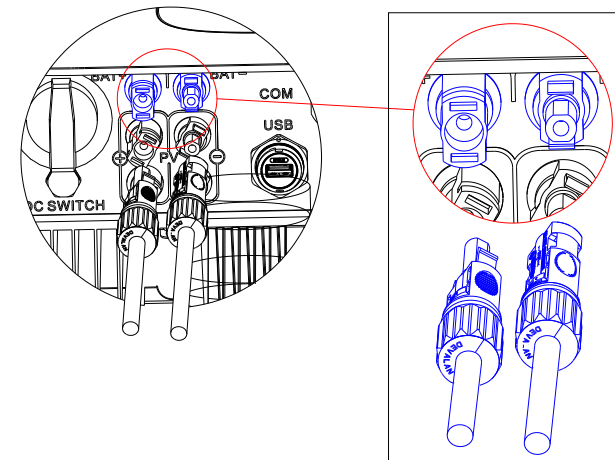
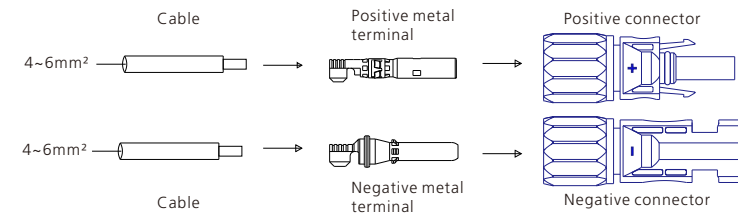

6.5.3 Connecting to Battery Pack

This series inverter support to connect lithium ion battery pack, the lithium ion battery pack has its own battery management system, the bidirectional DC/DC box connect to battery pack by RS485 or CAN, the XH series inverters connect to DC-DC box by RS485. In addition, XH series inverters also have a pair of signals for waking up the battery.

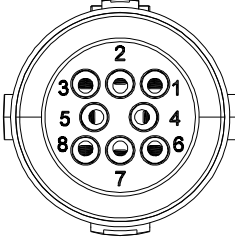
SYS COM Port Pin Definitions			
NO.	Port	Definition	Pin assignments front view
1	WAKE-	Connect Battery signal port negative	
2	WAKE+	Connect Battery signal port positive	
3	RS 485_A2	Connect Min ShineBus or Third party monitoring equipment	
4	RS 485_B2	Connect Min ShineBus or Third party monitoring equipment	
5	AntiReFlux_A	Connect meter signal RS485A	
6	AntiReFlux_B	Connect meter signal RS485B	
7	BAT_B	Connect Battery communication RS485B or CANL	
8	BAT_A	Connect Battery communication RS485A or CANH	

 CAUTION	<p>The communication interface RS485 or CAN between the Battery and the lithium ion battery pack is not properly connected or the electrical disconnection will cause the equipment to work abnormally, or even damage the equipment!</p>
---	---

6.6 Connecting signal cable

This series inverter has two 8 Pin signal connectors, one is COM PORT connector, another is SYS COM PORT connector. Signal Cable Ports as follows:

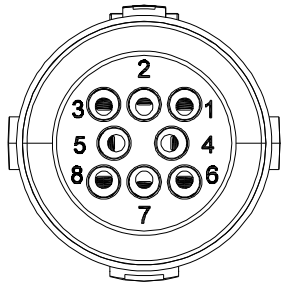

Procedure

Step 1 Insert the stripped and bared cable through pressure screw, seal ring, threaded sleeve in sequence, insert cables into connection terminal according to number indicates on it and tighten the screws firmly. Please try to pull out the wire to make sure the it's well connected.

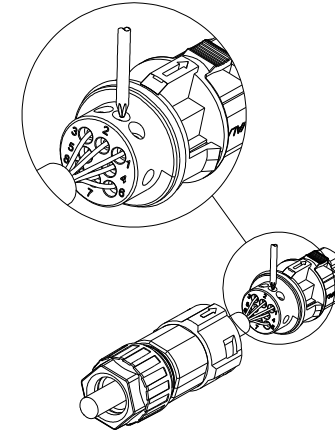

Step 2 Push the threaded sleeve into the socket, Tighten up the cap on the terminal.

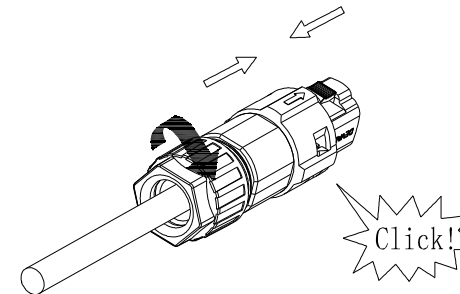

Step 3 Push the threaded sleeve to connection terminal until both are locked tightly on the inverter.

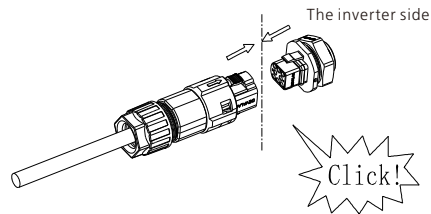

Uninstall signal connector

Step 1 Press the fasteners and pull it out from the inverter.

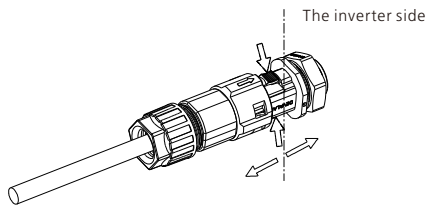

Step 2 Insert the H type tool and pull it out from the socket.

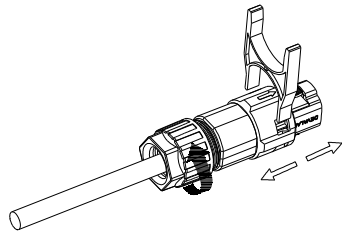

6.7 Grounding the inverter

The inverter must be connected to the AC grounding conductor of the power distribution grid via the ground terminal (PE).

 WARNING	<p>Because of the transformerless design, the DC positive pole and DC negative pole of PV arrays are not permitted to be grounded.</p>
--------------------	--

6.8 Active power control with smart meter , ripple control signal receiver

 Information	<p>The position of export limitation Meter must between the Inverter & Load and grid.</p>
------------------------	---

This series inverter has integrated export limitation functionality. To use this function, you can connect smart meter. The smart meter model is Eastron SDM230-Modbus, and others meter in Growatt list. The primary aperture is 10mm, output cable length is 5m . System connection block diagram is as follows:

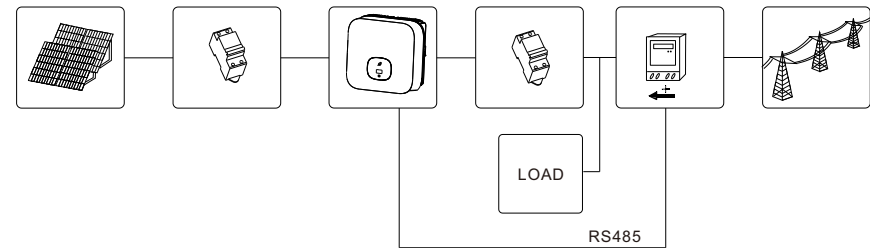

Active power control with a Radio Ripple Control Receiver(RRCR).

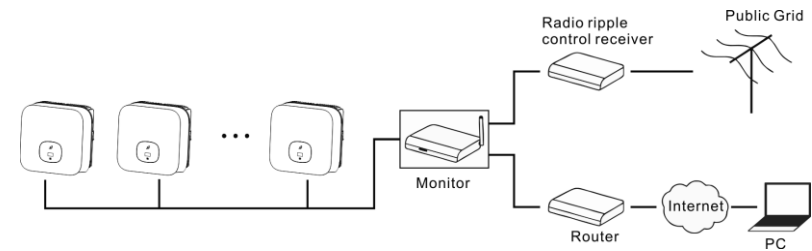



6.9 Connecting the COM PORT

This series inverter has a 8 Pin COM PORT, this port has the function fo demand response modes, for Australian mode, we can use the 8 Pin COM PORT as inverter DRED connection, for European modes, we can use the 8 Pin COM PORT as Power Control Interface(PCI).

6.9.1 Inverter demand response modes-DRMs(Australia only)

This series inverter has the function of demand response modes, We use 8Pin COM PORT as inverter DRED connection.

 Information	DRMS application description <ul style="list-style-type: none"> ➤ Only applicable to AS/NZS4777.2:2015. ➤ DRM0-DRM8 are available.
 CAUTION	Damage to the inverter due to moisture and dust penetration <ul style="list-style-type: none"> ➤ Make sure the cable gland has been tightened firmly. ➤ If the cable gland are not mounted properly, the inverter can be destroyed due to moisture and dust penetration. All the warranty claim will be invalid.

6.9.1.1 8Pin socket pin assignment

Pin	Assignment for inverters capable of both charging and discharging
1	+12V
2	GND
3	DRM 1/5
4	DRM 2/6
5	DRM 3/7
6	DRM 4/8
7	RefGen
8	Com/DRM0

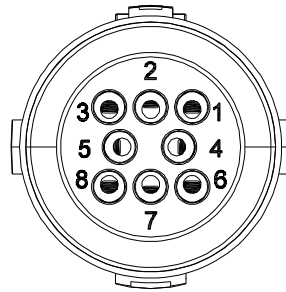

6.9.1.2 Method of asserting demand response modes

Mode	Socket Asserted by shorting pins		Requirement
DRM 0	7	8	Operate the disconnection device
DRM 1	3	8	Do not consume power
DRM 2	4	8	Do not consume at more than 50% of rated power
DRM 3	5	8	Do not consume at more than 75% of rated power
DRM 4	6	8	Increase power consumption
DRM 5	3	7	Do not generate power
DRM 6	4	7	Do not generate at more than 50% of rated power
DRM 7	5	7	Do not generate at more than 75% of rated power
DRM 8	6	7	Increase power generation (subject to constraints from other active DRMs)

6.9.2 Inverter demand response modes-Power Control Interface(PCI) for EU

This series inverter has the function of demand response modes, We use 8Pin COM PORT as Power Control Interface(PCI) for European models.

 WARNING	Excessive voltage can damage the inverter! External voltage of PCI PORT don't over +5V.
---	--

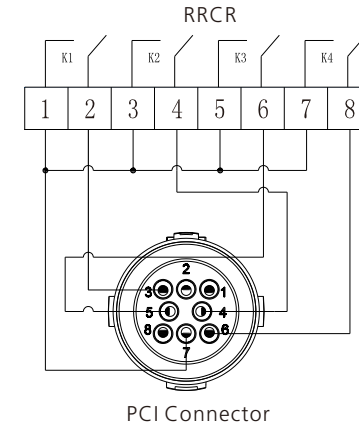

6.9.2.1 The connector pin assignment and function definition

Pin	Description	Connect to RRCR
1	+12V	Not connected
2	GND	
3	Relay contact 1 input	K1 – Relay 1 output
4	Relay contact 2 input	K2 – Relay 1 output
5	Relay contact 3 input	K3 – Relay 1 output
6	Relay contact 4 input	K4 – Relay 1 output
7	GND	Relays common node
8	Not connected	Not connected

6.9.2.2 The inverter is preconfigured to the following RRCR power levels

PCI Connector(SYS COM PORT)				Active power	Cos(φ)
Pin 3	Pin 4	Pin 5	Pin 6		
Short circuit with Pin7				0%	1
	Short circuit with Pin7			30%	1
		Short circuit with Pin7		60%	1
			Short circuit with Pin7	100%	1

Active power control and reactive power control are enabled separately

6.10 Electric arc hazards

6.10.1 Arc-Fault Circuit Interrupter(AFCI)

In accordance with the National Electrical Code R, Article 690.11, the inverter has a system for the recognition of electric arc detection and interruption. An electric arc with a power of 300 W or greater must be interrupted by the AFCI within the time specified by UL 1699B. A tripped AFCI can only be reset manually. You can deactivate the automatic arc fault detection and interruption (AFCI) via a communication product in "Installer" mode if you do not require the function. The 2011 edition of the National Electrical Code R, Section 690.11 stipulates that newly installed PV systems attached to a building must be fitted with a means of detecting and disconnecting serial electric arcs (AFCI) on the PV side.

6.10.2 Danger information

	<p>Danger of fire from electric arc</p> <p>Only test the AFCI for false tripping in the order described below.</p> <p>Do not deactivate the AFCI permanently.</p>
---	---

The inverter has double MPPTs, it is recommended for each MPPT to work independently, do not use parallel wiring at DC side (Parallel wiring can make 2 MPPTs become 1 MPPT, this can improve the efficiency in some cases). If the MPPTs are parallel wired at inverter it may cause the AFCI trigger mistakenly.

If an "Error 200" message is displayed, the red LED is permanently lit and the buzzer alarms, an electric arc occurred in the PV system. The AFCI has tripped and the inverter is in permanent shutdown.

The inverter has large electrical potential differences between its conductors. Arc flashes can occur through air when high-voltage current flows. Do not work on the product during operation.

6.10.3 Operation step

When the inverter error 200, please follow the steps:

Step1: Cut off all power supply connection of the inverter. Turn off the Battery input switch, turn off the inverter's AC output breaker, Turn the inverter's PV input DC Switch to position "OFF", wait for the display to go out;

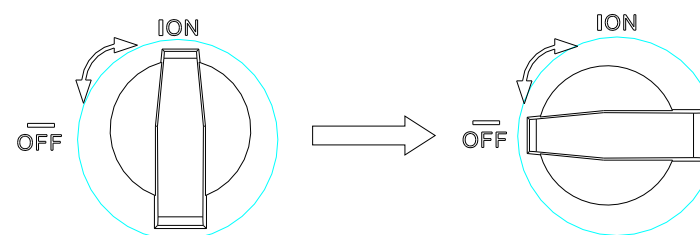

Step2: Perform troubleshooting on the system, Check all PV strings for the correct open-circuit voltage;

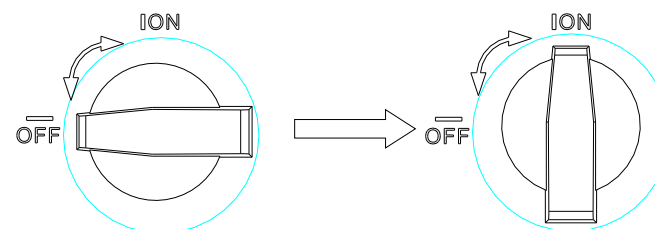

Step3: After the fault is rectified, restart the inverter. Turn on the Battery input switch, turn on the the inverter's AC output breaker, turn the inverter's PV input DC Switch to position "ON", Waiting for the system to work properly;



If the AFCI self-test is successful, the inverter will switch into the "nominal" mode and the green LED is permanently lit.

If the AFCI self-test is failed, the following message appears on the display: "Error 425", please restart the system, repeat step1 to step3.If the AFCI self-test continues to fail,cut off all power supply connection of the inverter,and contact Growatt to solve this problem.

7 Commissioning

 DANGER	Do not disconnect the PV&BAT connectors under load.
 WARNING	Improper operation during the wiring process can cause fatal injury to operator or unrecoverable damage to the inverter. Only qualified personnel can perform the wiring work.
 CAUTION	Damage to the inverter due to moisture and dust penetration <ul style="list-style-type: none"> ➢ Make sure the cable gland has been tightened firmly. ➢ If the cable gland are not mounted properly, the inverter can be destroyed due to moisture and dust penetration. All the warranty claim will be invalid.

Requirements :

- ✓ The AC cable is correctly connected.
- ✓ The PV&BAT connectors are correctly connected.
- ✓ The country is set incorrectly.

7.1 Start the inverter

7.1.1 Touch control

Touch	Description
Single touch	Switch display or Number + 1
Double touch	Enter or confirm
Three touch	Previous menu
Hold 5s	Confirm Country/Aera or recover default value

7.1.2 Set Country/Area

 Information	Country setting <ul style="list-style-type: none"> ➢ Before starts up the inverter,we need to select the right Country/Area,if we don't select any Country/Area, the inverter will run under AS/NZS4777.2 as default for Australia,or run under VDE0126-1-1 for other region after 30s.
---	---

When inverter powered on, OLED will light automatically. Once the PV power is sufficient, OLED displays "PV Inverter", Press the touch key once a second to scroll through the different Country, showing on the screen will constantly change. For example, if you want to choose Germany, press the touch key until the OLED display shows "VDE0126", Long press the touch key for 5 seconds, the OLED shows Country/Area setting is complete.

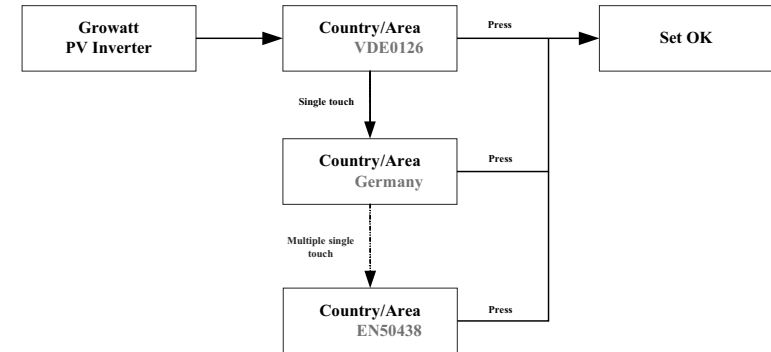

7.2 General setting

7.2.1 Set inverter display language

This series inverter provides multi languages. Single touch to select different language. Double touch to confirm the setting. Set the language as described below:

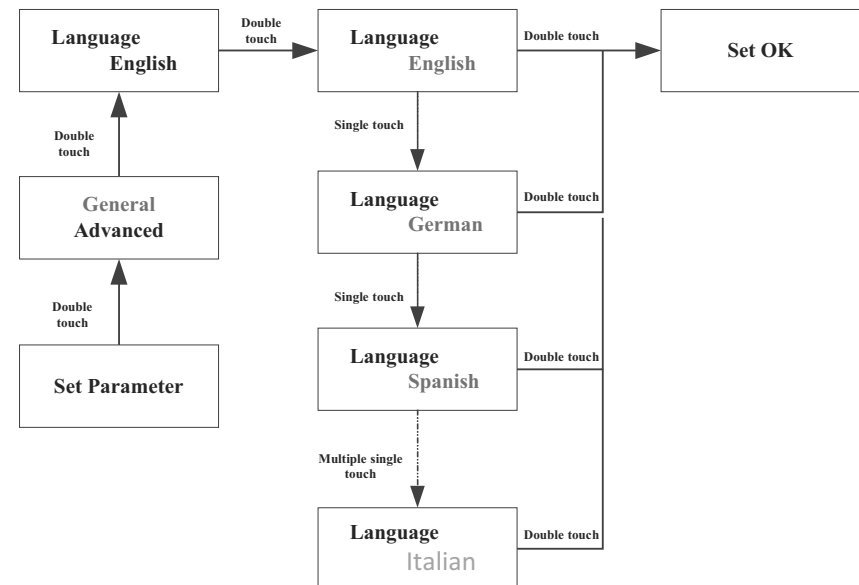

7.2.2 Set inverter COM address

The default COM address is 1. We can change COM address as described below: Single touch to switch display or make the number +1. Double touch to confirm the setting. Set inverter COM address as described below:

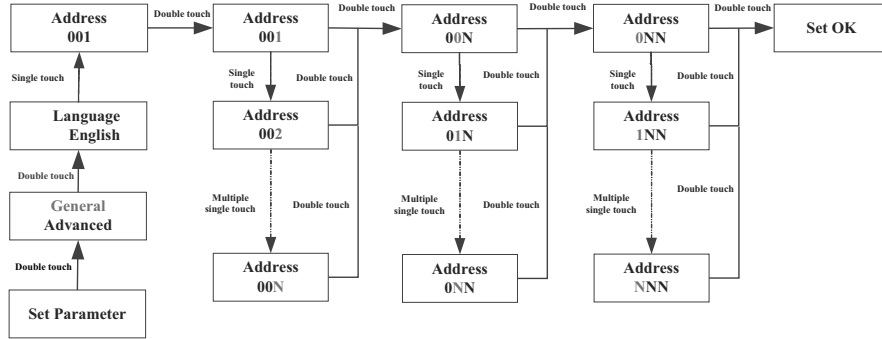

7.2.3 Set inverter date

Single touch make the number up. Double touch to confirm the setting. Set inverter date as described below:

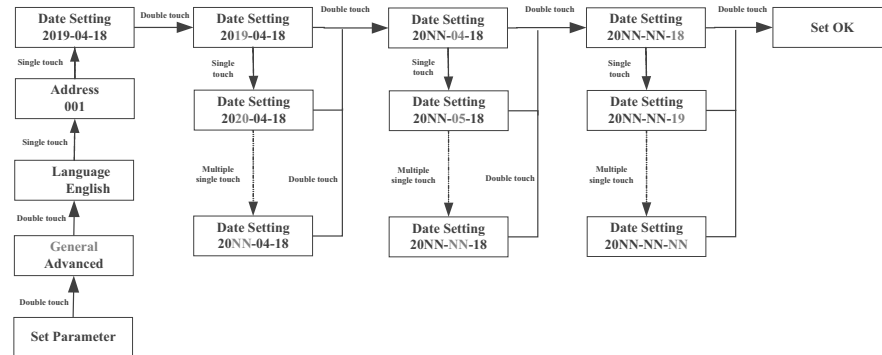

7.2.4 Set inverter time

Single touch make the number up. Double touch to confirm the setting. Set inverter time as described below:

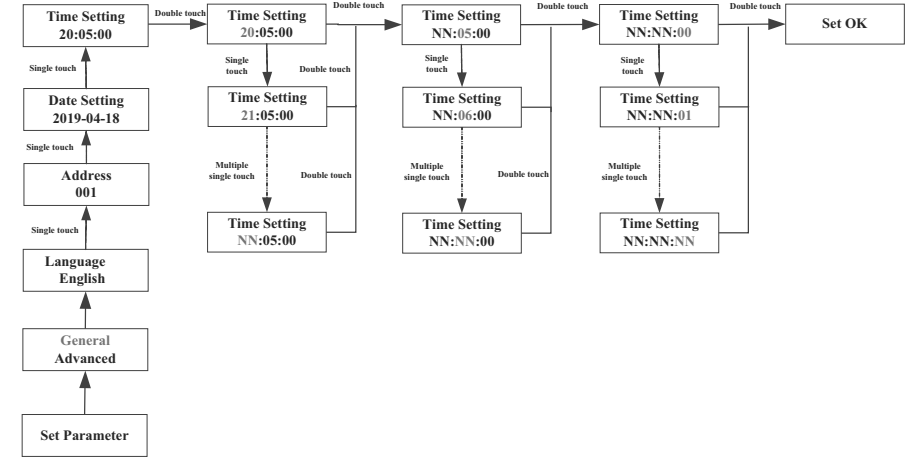

7.3 Advanced setting

7.3.1 Reset Country/Area

Single touch to switch display or make the number +1. Double touch to confirm the setting. The password of advanced setting is 123.

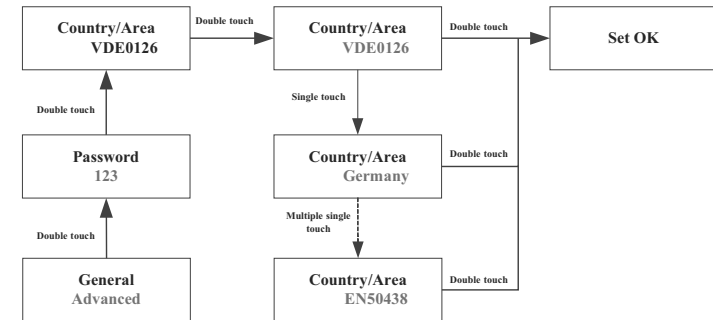

7.3.2 Export limitation setting

The -XH series inverters can work in anti-backflow mode through external power meter or CT, the user can set the percentage of power allowed to flow backward through

the OLED, Single touch to switch display or make the number +1. Double touch to confirm the setting, as described below:

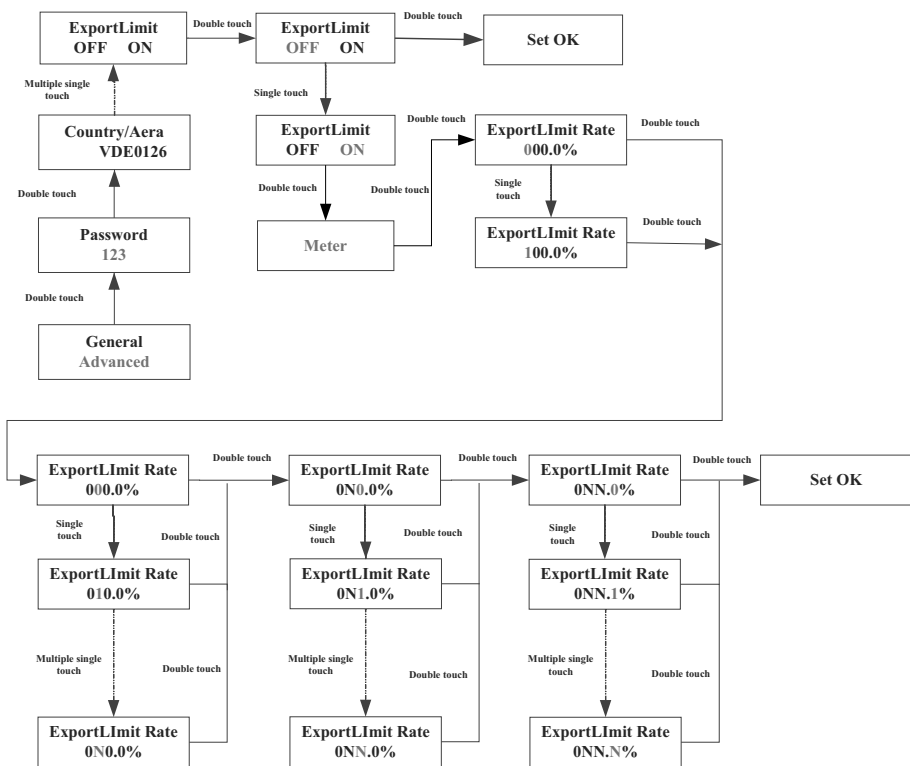

7.3.3 Reset factory



Information

Perform this operation with caution because all configured parameters except the current date, time, and model parameters will be restored to their factory defaults.

Single touch to switch display or make the number +1. Double touch to confirm the setting.

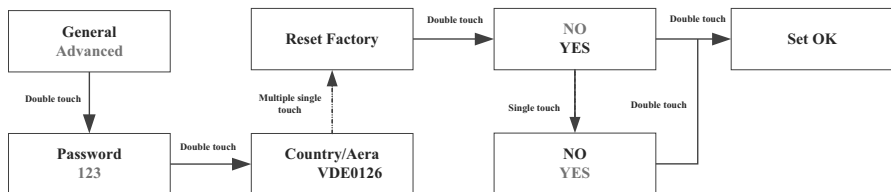

7.3.4 Backup mode setting

When the -XH series inverter is used with the Battery and the Backup Interface box, the Grid is abnormal, the inverter can work in backup mode to provide energy to the off-grid load. The maximum output power same as inverter rated power. In the Backup mode you can set the output voltage (default is 230V) and output frequency (default is 50Hz). If the Backup mode is disabled, the inverter will turn off the output when the grid is absent. The user can enable the Backup mode through OLED settings, Single touch to switch display or make the number +1. Double touch to confirm the setting, as described below:

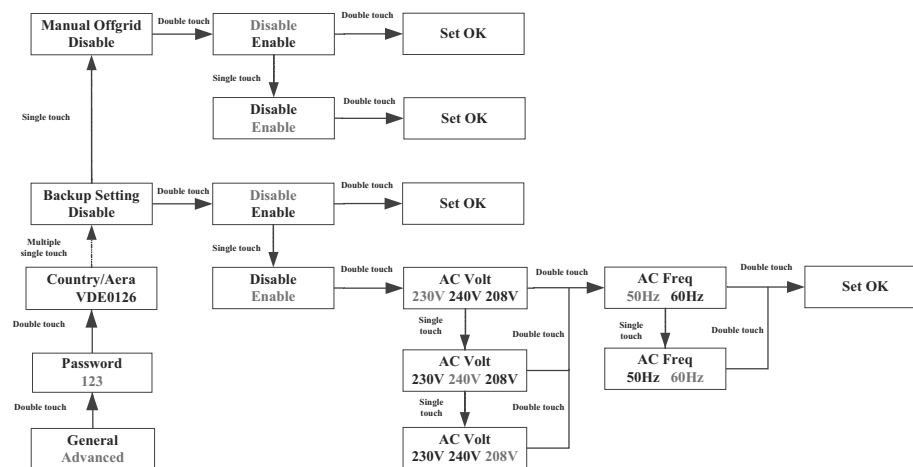

7.3.5 Work mode setting

When the -XH series inverter is used together with the Battery, the inverter has three working modes, Grid priority, Battery priority and Load priority (default is Load priority mode). Users can set the inverter to work in different modes in different time periods through OLED, Single touch to switch display or make the number +1. Double touch to confirm the setting, as described below: (If you want to set more time periods, you can use the Shinebus tool.)

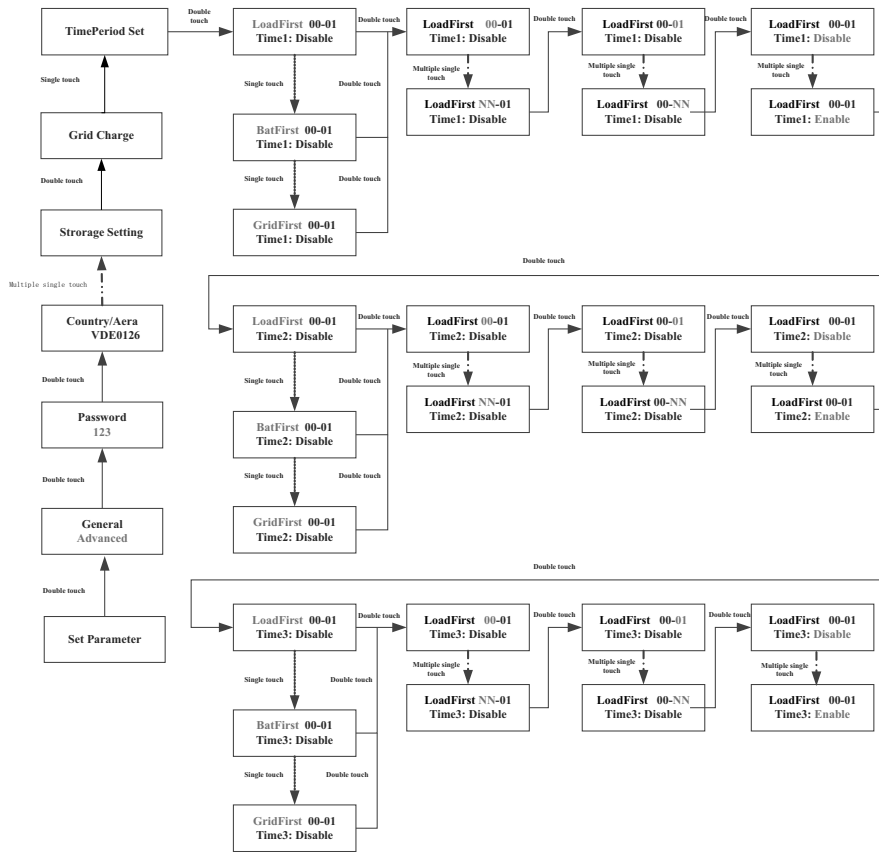

7.3.6 Grid Charge setting

When the -XH series inverter is used together with the Battery, the inverter can absorb the energy from the grid to charge the battery, and the user can enable the grid charging function (default is disable) through the OLED. Single touch to switch display or make the number +1. Double touch to confirm the setting. as described below:

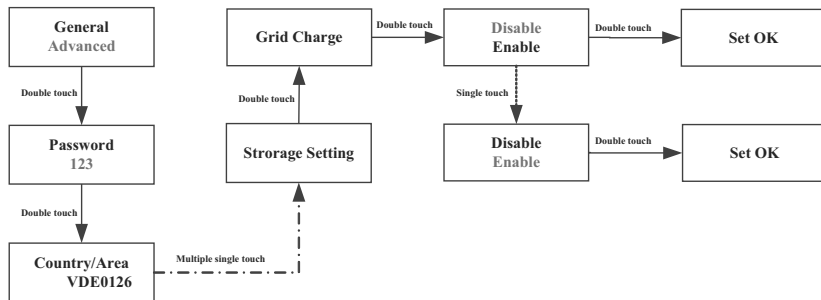

7.4 Communication interfaces

7.4.1 SYS COM Port

The -XH series inverter provides a 8 pin SYS COM Port connector. The SYS COM Port connector signal distribution and function are shown in the following table:

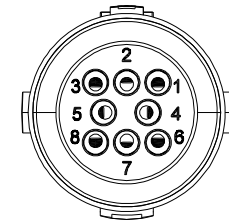

SYS COM Port Pin Definitions

NO	Definition	NO	Definition
1	Enable-: Connect the HV BAT enable signal port negative	5	RS485A1: Signal for meter
2	Enable+: Connect the HV BAT enable signal port positive	6	RS485B1: Signal for meter
3	RS485A2: Connect Min ShineBus or third party monitoring equipment	7	BAT-B: Connect the HV BAT communication RS485B or CANL
4	RS485B2: Connect Min ShineBus or third party monitoring equipment	8	BAT-A: Connect the HV BAT communication RS485A or CANH

7.4.2 COM Port

The -XH series inverter provides a 8 pin COM Port connector. The COM Port connector signal distribution and function, please refer to section 6.9.

7.4.3 USB-A

USB-A port is mainly for connecting monitor or firmware update: Through USB connection, we can connect external optional monitor, for example: Shine WIFI-X, Shine 4G-X, Shine LAN-X, ShineRFStick-X, ect. And also you can quickly update the software by U disk. We can monitor as below: Make sure the Δ on the front side, then insert the monitor, fasten the screw.

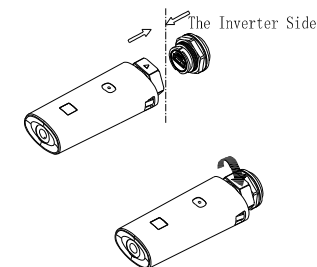

8 Startup and Shutdown the inverter

8.1 Startup the inverter

1. Connect the AC breaker of the inverter.
2. Turn on the dc switch, and the inverter will start automatically when the input voltage is higher than 70 V.

8.2 Shutdown the Inverter



Shut down the inverter step:

1. Disconnect the line circuit breaker from single-phases grid and prevent it from being reactivated.
2. Turn off the inverter's DC switch.
3. Turn off the BAT input switch of the HV BAT.
4. Check the inverter operating status.
5. Waiting until LED, OLED have go out, the inverter is shut down.

9 Maintenance and Cleaning

9.1 Checking Heat Dissipation

If the inverter regularly reduces its output power due to high temperature, please improve the heat dissipation condition. Maybe you need to clean the heat sink.

9.2 Cleaning the Inverter

If the inverter is dirty, turn-off the AC breaker, DC switch and the HV BAT input switch, waiting the inverter shut down, then clean the enclosure lid, the display, and the LEDs using only a wet cloth. Do not use any cleaning agents (e.g. solvents or abrasives).

9.3 Checking the DC Disconnect

Check for externally visible damage and discoloration of the DC Disconnect and the cables at regular intervals. If there is any visible damage to the DC Disconnect, or visible discoloration or damage to the cables, contact the installer.

- Once a year, turn the rotary switch of the DC Disconnect from the On position to the Off position 5 times in succession. This cleans the contacts of the rotary switch and prolongs the electrical endurance of the DC Disconnect.

EU Declaration of Conformity 10

With the scope of EU directives:

- 2014/35/EU Low Voltage Directive (LVD)
- 2014/30/EU Electromagnetic Compatibility Directive (EMC)
- 2011/65/EU RoHS Directive and its amendment (EU)2015/863

Shenzhen Growatt New Energy Technology Co. Ltd confirms that the Growatt inverters and accessories described in this document are in compliance with the above mentioned EU directives. The entire EU Declaration of Conformity can be found at www.ginverter.com.

Trouble shooting 11

Our quality control program assures that every inverter is manufactured to accurate specifications and is thoroughly tested before leaving our factory. If you have difficulty in the operation of your inverter, please read through the following information to correct the problem.

11.1 Error Messages displayed on OLED

An error message will be displayed on the OLED screen when a fault occurs. The faults consist of system fault and inverter fault.

You may be advised to contact Growatt in some situation, please provide the following information.

Information concerning the inverter:

- Serial number
- Model number
- Error message on OLED
- Short description of the problem
- Grid voltage
- DC input voltage
- Can you reproduce the failure? If yes, how?
- Has this problem occurred in the past?
- What was the ambient condition when the problem occurred?

Information concerning the PV panels:

- Manufacturer name and model number of the PV panel
- Output power of the panel
- Voc of the panel
- Vmp of the panel
- Imp of the panel
- Number of panels in each string

If it is necessary to replace the unit, please ship it in the original box.

11.2 System fault

System fault (system faults are mainly caused by system instead of inverter, please check the items as instructed below before replacing inverter).

Error message	Description	Suggestion
Residual I High Error: 201	Leakage current too high	1.Restart the invert. 2. If error message still exists, contact Growatt.
PV Voltage High Error: 202	The DC input voltage is exceeding the maximum tolerable value.	1. Disconnect the DC switch immediately. 2. Check the voltage of each PV string with multimeter. 3. If the voltage of PV string is lower than 550V, contact Growatt.
PV Isolation Low Error: 203	Insulation problem	1. Check if panel enclosure ground properly. 2. Check if inverter ground properly. 3. Check if the DC breaker gets wet. 4. Check the impedance of PV (+) & PV (-) between ground (must be more than 25 KΩ or 550 KΩ(VDE 0126). If the error message is displayed despite the above checking passed, contact Growatt.
AC V Outrange Error: 300	Utility grid voltage is out of permissible range.	1.Please switch off DC switch. 2.Check AC wiring, especially neutral and ground wire. 3.Check grid voltage is complied with local grid standard. Restart inverter, if problem still exist, 4.Contact Growatt.
No AC connection Error: 302	No AC connection	1.Check AC wiring. 2.Check the status of AC breaker
PE abnormal Error: 303	Voltage of Neutral and PE above 30V.	1.Check the voltage of Neutral and PE. 2.Check AC wiring. 3.Restart inverter, if error message still exists,contact Manufacturer

AC F Outrange Error: 304	Utility grid frequency out of permissible range.	1.Please switch off DC switch. 2.Check AC wiring, especially neutral and ground wire. 3.Check grid frequency is complied with local grid standard. 4.Restart inverter, if problem still exist, Contact Growatt.
Auto Test Failed Error: 407	Auto test didn't pass.	1.Restart inverter, repeat Auto Test, if problem still exist, contact Growatt.

11.3 Inverter warning

Warning code	Meanings	Suggestion
Warning 203	PV1 or PV2 Circuit short	1.Check the PV panel polarity. 2.Restart the inverter. If the warning still exist, please contact Growatt customer service to replace the POWER board.
Warning204	Dryconnect function abnormal	1.After shutdown,Check the dry Dryconnect wiring. 2.If the error message still exists, contact manufacturer.
Warning 205	PV1 or PV2 boost broken	1.Restart the inverter. If the warning still exist, please contact Growatt customer service to replace the power board.
Warning207	USB over-current	1.Unplug the U disk or monitor. 2.Re-access U disk or monitor after shutdown. 3.If the error message still exists, contact manufacturer.
Warning 401	Inverter communicates with Meter abnormal	1.Check if the meter is on. 2.Check the inverter and the meter connection is normal .
Warning404	EEPROM abnormal	1.Restart the inverter. If the warning still exist, please contact Growatt customer service to replace the M3 board.
Warning405	Firmware version is not consistent	1.Uptate the right version firmware

Manufacturer Warranty 12

11.4 Inverter fault

Error code	Meanings	Suggestion
Error: 402	Output High DCI	1.Restart inverter, if problem still exist, Contact Growatt.
Error: 404	Bus sample fault	1.Restart inverter, if problem still exist, Contact Growatt.
Error: 405	Relay fault	1.Restart inverter, if problem still exist, Contact Growatt.
Error: 408	Over Temperature	1.If the ambient temperature of inverter is lower than 60°C, restart inverter, if error message still exists, contact Growatt.
Error: 409	Bus over voltage	1.Restart inverter, if problem still exist, Contact Growatt.
Error: 411	DSP communicates with M3 abnormal	1.Restart inverter, if problem still exist, update the DSP&M3 firmware ; 2.Change DSP board or M3 board, if problem still exist, contact Growatt.
Error: 414	EEPROM fault.	1.Restart inverter,if problem still exist, contact Growatt.
Error: 417	The data sampled by the DSP and redundant M3 is not the same.	1.Restart inverter,if problem still exist, contact Growatt.
Error: 420	GFCI fault.	1.Restart inverter,if problem still exist, contact Growatt.

Please refer to the warranty card.

Decommissioning 13

13.1 Dismantling the Inverter

1. Disconnect the inverter as described in section.
2. Remove all connection cables from the inverter.

 CAUTION	<p>Danger of burn injuries due to hot enclosure parts! Wait 20 minutes before disassembling until the housing has cooled down.</p>
---	---

3. Screw off all projecting cable glands.
4. Lift the inverter off the bracket and unscrew the bracket screws.

13.2 Packing the Inverter

If possible, always pack the inverter in its original carton and secure it with tension belts. If it is no longer available, you can also use an equivalent carton. The box must be capable of being closed completely and made to support both the weight and the size of the inverter.

13.3 Storing the Inverter

Store the inverter in a dry place where ambient temperatures are always between -25°C and +60°C.

13.4 Disposing of the Inverter



Do not dispose of faulty inverters or accessories together with household waste. Please accordance with the disposal regulations for electronic waste which apply at the installation site at that time. Ensure that the old unit and, where applicable, any accessories are disposed of in a proper manner.

14 Technical Data

14.1 Specification

Specifications	Model	MIN 2500 TL-XH	MIN 3000 TL-XH	MIN 3600 TL-XH	MIN 4200 TL-XH
PV input quantities					
Max. recommended PV power(for module STC)		5000W	6000W	7200W	8400W
Vmax PV		500V		550V	
Start voltage		100V			
Nominal voltage		360V			
MPP voltage range		70-500V	70-500V	70-550V	70-550V
MPP voltage range at Full Power		100V-450V	120V-450V	150V-500V	170V-500V
No. of MPP trackers		2			
No. of PV strings per MPP trackers		1			
Max. input current per MPP trackers		13.5A			
Max. short-circuit current per MPP trackers		16.9A			
Max. inverter backfeed current to the array		0A			
DC input quantities					
Nominal DC input voltage		400V			
DC input voltage range		360-550V			
Battery voltage rang		96-460V			
DC input current(maximum continuous)		17A			
DC output quantities					
Nominal DC input voltage		400V			
DC input voltage range		360-550V			
DC input current(maximum continuous)		17A			
Battery type		Lithium ion battery			
AC output quantities					
Nominal AC power		2500W	3000W	3600W	4200W
Nominal AC apparent power		2500VA	3000VA	3600VA	4200VA
Nominal AC voltage		230V			
AC voltage range		160-276V			
Norminal AC grid frequency		50/60Hz			

AC grid frequency range	45-55Hz/55-65Hz			
Max. output current	11.3A	13.6A	16A	19A
Inrush current	<10A			
Max. output fault current	60A			
Max.output overload protection	16A	16A	20A	25A
Backfeed current	0A			
Power factor(@nominal power)	>0.99			
Power factor range	0.8leading... 0.8lagging			
THDi	<3%			
AC grid connection type	Single phase(L/N/PE)			
AC overvoltage category	Category III			
AC input quantities				
Nominal AC input voltage	230V			
AC input voltage range	160-276V			
AC input current(maximum continuous)	11.3A	13.6A	16A	19A
Inrush current	<10A			
Nominal frequency	50/60Hz			
AC input frequency range	45-55Hz/55-65Hz			
Efficiency				
Max. efficiency	98.2%	98.2%	98.2%	98.4%
Euro-eta	97.1%	97.1%	97.2%	97.2%
Protection devices				
DC reverse-polarity protection	Integrated			
DC switch	Integrated			
DC Surge protection class	Type II			
Insulation resistance monitoring	Integrated			
AC surge protection class	Type III			
AC short-circuit protection	Integrated			
Ground fault monitoring	Integrated			
Grid monitoring	Integrated			
Anti-islanding protection	Integrated			
Residual-current monitoring unit	Integrated			
General data				
Dimensions (W / H / D) in mm	375*350*160			
Weight	10.8 kg			
Operating temperature range	- 25 °C ... +60 °C			

Noise emission (typical)	25 dB(A)
Altitude	4000m
Internal consumption at night	<10W
Topology	Non-isolated
Overvoltage category	PV:II AC:III BAT:II Others:I
Cooling	Natural convection
Ingress protection	IP65
Pollution degree outside the enclosure	3
Pollution degree inside the enclosure	2
Relative humidity	0~100%
DC connection	Helios H4-R/VP-D4/MC4
AC connection	AC connector
Interfaces	
Display	OLED+LED
RS485/USB	Integrated
WIFI/GPRS/4G/LAN/ RF	Optional
Warranty:5/10 years	Yes/ Optional

Model	MIN 4600 TL-XH	MIN 5000 TL-XH	MIN 6000 TL-XH
Specifications			
PV input quantities			
Max. recommended PV power(for module STC)	9200W	1000W	1000W
Vmax PV	550V		
Start voltage	100V		
Nominal voltage	360V		
PV input operating voltage range	70-550V		
MPP voltage range at Full Power	185V-500V	200V-500V	240V-500V
No. of MPP trackers	2		
No. of PV strings per MPP trackers	1		
Max. input current per MPP trackers	13.5A		
Isc PV per MPP trackers	16.9A		
Max. inverter backfeed current to the array	0A		
PV overvoltage category	Category II		
DC input quantities			
Nominal DC input voltage	400V		
DC input voltage range	360-550V		
DC input current(maximum continuous)	17A		
DC output quantities			
Nominal DC input voltage	400V		
DC input voltage range	360-550V		
DC input current(maximum continuous)	17A		
Battery type	Lithium ion battery		
AC output quantities			
Nominal AC power	4600W	5000W	6000W
Nominal AC apparent power	4600VA	5000VA	6000VA
Nominal AC voltage	230V		
AC voltage range	160-276V		
Nominal AC grid frequency	50/60Hz		
AC grid frequency range	45-55Hz/55-65Hz		

Nominal output current	20.9A	22.7A	27.2A
Inrush current	10A		
Max. output fault current	60A		
Max. output overload protection	25A	32A	32A
Backfeed current	0A		
Power factor(@nominal power)	>0.99		
Adjustable power factor	0.8leading... 0.8lagging		
THDi	<3%		
AC grid connection type	Single phase(L/N/PE)		
AC overvoltage category	Category III		
AC input quantities			
Nominal AC input voltage	230V		
AC input voltage range	160-276V		
AC input current(maximum continuous)	20.9A	22.7A	27.2A
Inrush current	<10A		
Nominal frequency	50/60Hz		
AC input frequency range	45-55Hz/55-65Hz		
Efficiency			
Max. efficiency	98.4%	98.4%	98.4%
Euro-eta	97.5%	97.5%	97.5%
Protection devices			
DC reverse-polarity protection	Integrated		
DC switch	Integrated		
DC Surge protection class	Type II		
Insulation resistance monitoring	Integrated		
AC surge protection	Type III		
AC short-circuit protection	Integrated		
Ground fault monitoring	Integrated		
Grid monitoring	Integrated		
Anti-islanding protection	Integrated		
Residual-current monitoring unit	Integrated		
General data			
Dimensions (W / H / D) in mm	375*350*160		
Weight	10.8 kg		
Operating temperature range	- 25 °C ... +60 °C		
Noise emission (typical)	25 dB(A)		

Altitude	4000m
Internal consumption at night	<10W
Topology	Non-isolated
Overvoltage category	PV:II AC:III BAT:II Others:I
Cooling	Natural convection
Protection degree	IP65
Pollution degree outside the enclosure	3
Pollution degree inside the enclosure	2
Relative humidity	0~100%
DC connection	Helios H4-R/VP-D4/MC4
AC connection	AC connector
Interfaces	
Display	OLED+LED
RS485/USB	Integrated
WIFI/GPRS/4G/LAN/ RF	Optional
Warranty:5/10 years	Yes/ Optional

* The AC Voltage Range may vary depending on specific country grid standard. All specifications are subject to change without notice.

Compliance Certificates 15

14.2 PV&BAT &AC connectors info

PV&BAT connectors	Helios H4-R/VP-D4/MC4
AC connector	M-S30_SD03_S10 001U-A VPAC06EP-3S(SC)5 VPAC06EW-3P(SC)

14.3 Torque

Enclosure lid screws	7kg.cm
AC terminal	6kg.cm
Signal terminal	0.4N.m
M6 socket head cap screws for securing the enclosure at the bracket	20kg.cm
Additional ground screws	20kg.cm

14.4 Accessories

In the following table you will find the optional accessories for your product. If required, you can order these from GROWATT NEW ENERGY TECHNOLOGY CO.,LTD or your dealer.

Name	Brief description
Shine WIFI-X	WIFI monitor with USB interface
Shine 4G-X	4G monitor with USB interface
Shine RF-X	RF monitor with USB interface
Shine LAN-X	LAN monitor with USB interface
RS485 Meter	External energy meter for inverter
Shine Master	Shine master for inverter

Shipped to a Growatt service centre for repair, or repaired on-site, or exchanged for a replacement device of equivalent value according to model and age. The warranty shall not cover transportation costs in connection with the return of defective modules. The cost of the installation or reinstallation of the modules shall also be expressly excluded as are all other related logistical and process costs incurred by all parties in relation to this warranty claim.

Certificates

With the appropriate settings, the unit will comply with the requirements specified in the following standards and directives (dated: May./2021):

Model	Certificates
MIN 2500-6000TL-XH	CE,IEC 62109,AS4777.2,CEI 0-21,VDE0126-1-1,VRF 2019,VDE-AR-N4105,EN50549,IEC62116,IEC61727,G98,G99

Contact 16

If you have technical problems about our products, contact the GROWATT Serviceline. We need the following information in order to provide you with the necessary assistance:

- Inverter type
- Serial number of the inverter
- Event number or display message of the inverter
- Type and number of PV modules connected
- Optional equipment

SHENZHEN GROWATT NEW ENERGY Co.,LTD

- No.28 Guangming Road, Longteng Community, Shiyan, Bao'an District, Shenzhen, P.R.China
- www.ginverter.com
- Serviceline
- Tel: + 86 755 2747 1900
- Email: service@ginverter.com