



ZNSHINE PV MODULES INSTALLATION MANUAL

Double glass & Bifacial double glass Modules

ZNSHINE PV-TECH CO.,LTD.

No.1, South Zhenxing Road, Zhixi Town Industry Concentration Zone, Jintan Zone, Changzhou, Jiangsu Province, China.

Tel: +86 519 6822 0233

E-mail: info@znshinesolar.com

DOCUMENT COUNTERSIGN			
DEPARTMENT	Product Technology Department	Quality Department	Marketing Center
COUNTERSIGNER			
DOCUMENT NO.	QES/ZX-RD-032A	COMPILER	
EDITION	A	REVIEWER	
EFFECTIVE DATE	2020.10.13	APPROVER	

DOUBLE GLASS & BIFACIAL DOUBLE GLASS INSTALLATION MANUAL

1、 INTRODUCTION FOR USER MANUAL	- 1 -
1.1、 DISCLAIMER.....	- 1 -
1.2、 LIMITATION OF LIABILITY.....	- 1 -
2、 SAFETY PRECAUTIONS	- 1 -
2.1、 WARNING.....	- 1 -
2.2、 GENERAL SAFETY.....	- 1 -
2.3、 HANDLING SAFETY.....	- 2 -
3、 UNLOAD/TRANSPROTATION/STORAGE	- 3 -
3.1、 MAKERS ON OUTER PACKAGING.....	- 4 -
3.2、 UNLOADING WARNNING.....	- 5 -
3.3、 SECONDARY TRANSPORT AND WARNING.....	- 6 -
3.4、 STORAGE.....	- 7 -
4、 UNPACKING SAFETY	- 7 -
5、 INSTALLATION	- 8 -
5.1、 INSTALLATION SAFETY.....	- 8 -
5.2、 ENVIRONMENT CONDITIONS AND SITE SELECTION.....	- 9 -
5.3、 TILT ANGLE OF INSTALLATION.....	- 10 -
5.4、 INSTALLATION REQUIREMENTS FOR BIFACIAL CELLS MODULE.....	- 11 -
5.5、 INSTALLATION METHOD.....	- 11 -
5.5.1 MECHANICAL INSTALLATION AND WARNING.....	- 11 -
5.5.2 ELECTRICAL INSTALLATION.....	- 21 -
6、 MODULE MAINTENANCE	- 25 -
6.1、 PANEL VISUAL INSPECTION AND REPLACEMENT.....	- 25 -
6.2、 CONNECTOR AND CABLE INSPECTION.....	- 25 -
6.3、 CLEANING.....	- 26 -
6.3.1 MODULE INSPECTION AFTER CLEANING.....	- 27 -
6.3.2 TROUBLESHOOTING.....	- 27 -
7、 SPECIFICATION FOR SOLAR MODULE BARCODE	- 28 -
8、 TECHNICAL DATA	- 29 -

1、 INTRODUCTION FOR USER MANUAL

This general manual applies to the installation, maintenance and use of the double glass solar modules manufactured by ZNSHINE PV-TECH Co.,Ltd. (hereinafter referred to as “ZNSHINE SOLAR”). Failure to follow these instructions could result in personal injury or property damage.

Installation and operation of PV modules requires professional skills and should only be performed by qualified professionals. Please read the “Safety and Installation Instructions” carefully before using and operating the modules.

The word “module” or “PV module” used in this manual refers to one or more double glass solar modules. Please keep this manual for future reference.

1.1、 DISCLAIMER

1、 ZNSHINE PV-TECH Co., LTD reserves the rights to change this User Manual without prior notice. Please refer to our product lists and documents published on our website at: <https://www.znshinesolar.com> as these lists are updated on a regular basis.

2、 Failure of the customer to follow the requirements outlined in this Manual during the installation of the module will result in the invalidity of product's limited warranty.

3、 ZNSHINE SOLAR is not responsible for any infringement of third party patents or any other rights arising from the use of solar PV modules.

4、 The information in this manual is based on ZNSHINE SOLAR’s knowledge and experience and is believed to be reliable, but such information including product specification (without limitations) and suggestions Do not constitute a warranty, expresses or implied.

1.2、 LIMITATION OF LIABILITY

ZNSHINE SOLAR is not responsible for any form of damage, including but not limited to module operation and system installation error, and personnel injury, hurt, and property loss resulting from failure to follow the instructions in this Manual.

2、 SAFETY PRECAUTIONS

2.1、 WARNING

Before attempting to install, wire, operate and/or service the module and other electrical equipment, all instructions should be read and understood. Direct current (DC) is generated when the battery surface of the module is exposed to direct sunlight or other light sources, and direct contact with the live parts of the module, such as terminals, may result in death of personnel whether connected to the module or not .

2.2、 GENERAL SAFETY

ZNSHINE SOLAR modules are designed to meet the requirements of IEC 61215 and IEC 61730, application class A. Modules rated for use in this application class may be used in system operating at greater than 50V DC or 240W, where general contact access is anticipated. Modules qualified for safety through IEC 61730-1 and IEC 61730-2 and within this application class are considered to meet the requirements for safety class II equipment.

(1) All installation work must comply with the local codes and the relevant international electrical standards.

(2) ZNSHINE SOLAR recommends that PV module installation is conducted by personnel who have been professionally trained in PV system installation. Operation by personnel who are not familiar with the relevant safety procedures will be very dangerous.

(3) Do not allow unauthorized persons to access the installation area or module storage area.

- (4) Protective clothing (non-slip gloves, clothes, etc.) must be worn during installation to prevent direct contact with 30V DC or greater, and to protect hands from sharp edges.
- (5) Prior to installation, remove all metallic jewelry to prevent accidental exposure to live circuits.
- (6) When installing modules in light rain, morning dew, take appropriate measures to prevent water ingress into the connectors, f. e. using connector endcaps.
- (7) Use electrically insulated tools to reduce the risk of electric shock.
- (8) Do not use or install broken modules.
- (9) External or artificially concentrated sunlight shall not be directed onto the front or back face of the PV module.
- (10) Do not contact module surface if the front or rear glass is broken. This may cause electric shock.
- (11) Do not attempt to repair, disassemble or move any part of the PV module. The module does not contain any reusable parts.
- (12) Do not connect or disconnect the module when it is energized or connected with an external power supply.

2.3、HANDLING SAFETY

- (1) Do not stand, walk on or lean on the module directly.

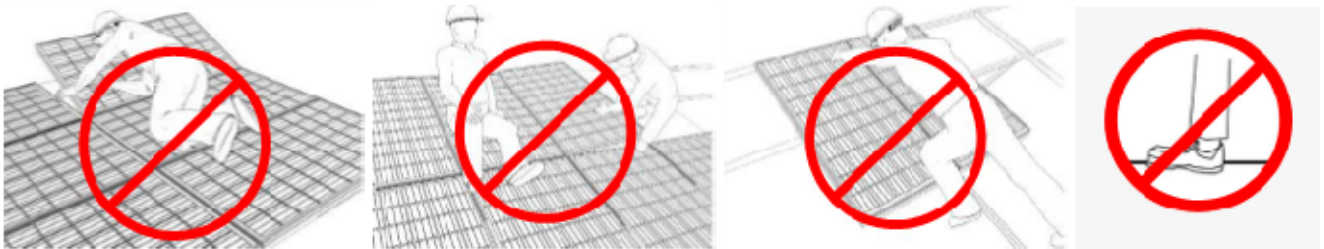

- (2) Do not damage or scratch the front or backside surfaces of the module.
- (3) Do not drag. Scratch, bend the output cable with force or with too tight connection. The insulation of output cable can break and may result in electricity leakage or shock.
- (4) If there is an open fire, please extinguish it with a dry powder extinguisher after disconnecting the power supply, can not use liquid such as water to extinguish the fire.
- (5) Do not install or handle modules when they are wet or during periods of high wind.
- (6) At the installation site, take care to keep modules and in particular their electrical contacts, clean and dry before installation. If connector cables are left in damp conditions then the contacts may corrode. Any module with corroded contacts should not be used.
- (7) Please Do not loosen, unscrew or peel the PV module bolts and frame glue. This may lead to a reduction of the module's load rating and potential damage from a fall.
- (8) Do not drop PV modules or allow objects to fall down on the PV modules.
- (9) Do not touch the terminal box or the ends of the output cables (connectors) with bare hands under sunlight, regardless of whether the PV module is connected to or disconnected from the system.
- (10) Do not discard the modules at will; special recycling is required.

3、UNLOAD/TRANSPORTATION/STORAGE

Precautions and general safety rules:

(1) Modules should be stored in a dry and ventilated environment to avoid direct sunlight and moisture and extra precautions should be taken to prevent connectors from being exposed to moisture or sunlight, like using connector endcaps.

(2) The modules should be stored in the original ZNSHINE SOLAR package before installation. Protect the package from damage. Unpack the modules as per the recommended unpacking procedures. The whole process of unpacking, transport and storing should be handled with care.

(3) Before installation, ensure that all modules and electrical contacts are clean and dry.

(4) Unpacking must be carried out by two or more persons at the same time.

(5) Handling the modules requires two or more people with nonslip gloves and both hands.

(6) Do not lift modules by their wires or junction box.

(7) Do not handle the modules over-head or stack the modules.

(8) Do not place excessive loads on the module or twist the module.

(9) Do not drop or place objects (such as tools) on the modules.







(10) Do not put the modules in a place that is not supported or stable.

(11) Do not allow the modules to come in contact with sharp-pointed objectives to prevent them from scratches, avoiding a direct impact on the safety of modules.

(12) Do not expose the modules and its connectors to any chemical substance (e.g. oil, lubricant, pesticide, etc.).

(13) Before the secondary transportation vehicle is started, it should be bundled with net ropes. The rope should be fastened to prevent damage to the modules during the transportation. The speed of the vehicle carrying the modules should be ≤ 5 km/h.

3.1. MAKERS ON OUTER PACKAGING

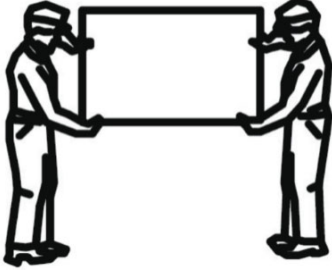
<p>3.1.1 Need both hands to handle it carefully.</p> 	<p>3.1.2 Uninstalled modules must be kept dry, not expose to rain or moisture.</p> 
<p>3.1.3 Modules in carton are fragile, which must be handled with care.</p> 	<p>3.1.4 The packaging must be transported upright.</p> 
<p>3.1.5 Do not step on the package and module.</p> 	<p>3.1.6 Modules shall be stacked as required, not exceeding the maximum number of layers printed on the outer packaging. (no more than two layers).</p> 
<p>3.1.8 One module shall be handled by at least two persons together. Modules are placed vertically.</p> 	

3.2、 UNLOADING WARNING

3.2.1 Use a suitable lifting fixture to handle, no more than 2 pallets of modules. Before lifting, check whether the tray and the carton are damaged and whether the hoisting ropes are strong and firm. Two people shall support at the two sides of the righting carton gently to place it on the relatively flat position of the project site.



3.2.2 Use a forklift to remove the module pallets from the truck.

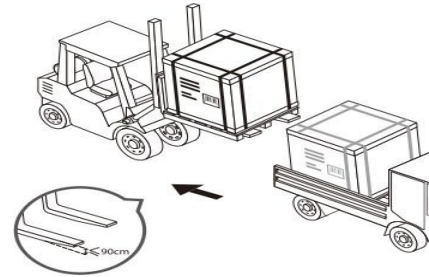

3.2.3 Put the modules on level ground.

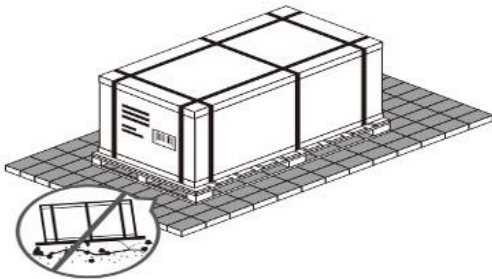

3.2.4 Do not stack the modules at the project site.

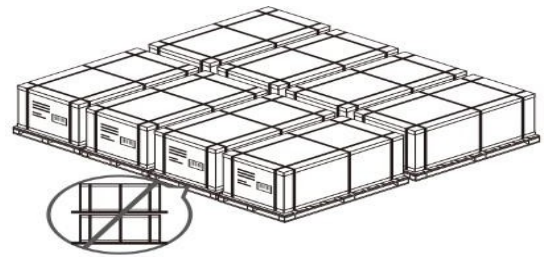

3.2.5 Store the module in a dry and ventilated place.

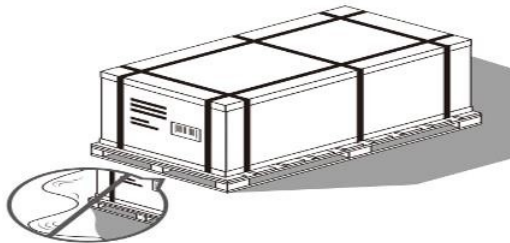

3.2.6 Cover the module with waterproof material to prevent it from moisture.



3.3. SECONDARY TRANSPORT AND WARNING

3.3.1 Do not remove the original packages if the modules require long-distance transport or long-term storage.

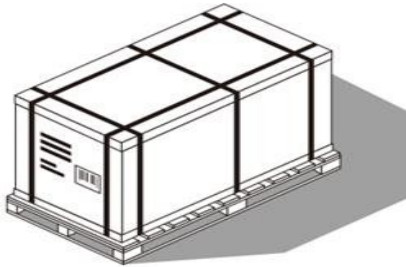

3.3.2 Packaged products can be transported by land, sea or air. During transportation, make sure that the package is fixed securely to the shipping platform without movement. Do not Stack more than two layers on truck.

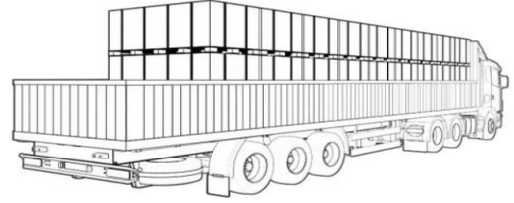

3.3.3 Only one layer stacking is only allowed for transport at the project site.

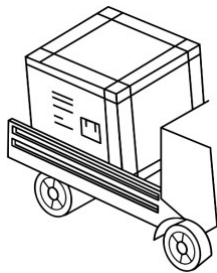

3.3.4 No transport or handling by pedi-cab or improper vehicle as shown below.

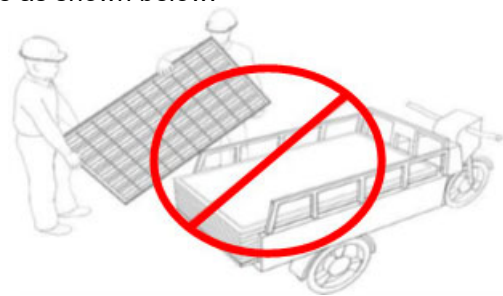

3.3.5 Do not transport the module with rope as shown below.

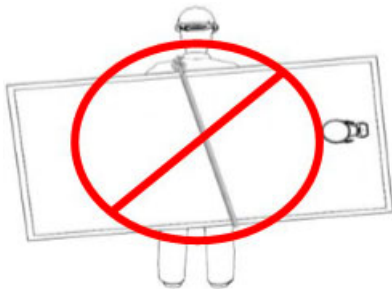

3.3.6 Do not carry the modules on the back of one person as shown below.



3.4、STORAGE

- 1、 Do not remove the original packaging if the module requires long-distance transport or long-term storage.
- 2、 Do not expose the modules to rain or moisture. Store the finished product in a well ventilated, waterproof, dry and smooth place.
- 3、 Do not stack modules more than 2 layers. (moisture<85%RH, temperature range from -20°C to + 50 °C)
- 4、 The module must be installed as soon as possible in the project site and must not be exposed to rain or damp. ZNSHINE SOLAR shall not be responsible for any damage or collapse of the modules caused by moisture in the packaging.

4、UNPACKING SAFETY

- (1) For unpacking outdoors, it is prohibited to operate in rainy conditions. Because the carton will become soft and damaged after it gets wet in the rain. The stacked PV modules (hereinafter referred to as "modules") may tip over, which may cause damage or injury to personnel.
- (2) For a windy site, it is necessary to pay special attention to safety. Especially, it is not recommended to transport or unpacking the modules in high wind conditions. The unpacked modules must be tied down to avoid any unwanted movement.
- (3) The work surface is required to be level to ensure that the package can be placed stably, avoiding sliding.
- (4) Wear protective gloves during unpacking to avoid hand injury and fingerprints on the glass surface.
- (5) Each module shall be handled by two persons. It is forbidden to pull the wires or junction boxes and frame of the modules to carry the module.

5. INSTALLATION

5.1. INSTALLATION SAFETY

(1) Znshine Solar Modules can be mounted in landscape or portrait orientation, the impact of dirt shading the solar cells can be minimized by orienting the product in landscape.

(2) Always wear dry insulation protection equipment: insulated tools, head gear, insulated gloves, safety belt and safety shoes (with rubber soles).

(3) Make sure flammable gasses are not generated or present near the installation site.

(4) Do not install modules under rain, snow or windy conditions. Place disassembled PV modules correctly.

(5) Keep the PV module packed in the carton until installation. Please install immediately after unpacking. Please keep the connector dry and clean during installation to avoid the risk of electric shock. Do not perform any work if the terminals of PV module are wet, until they are dry.

(6) Please take measures to insulate during PV module installation and wiring.

(7) Do not touch the junction box and the end of the interconnect cables (connectors) with bare hands during installation or under sunlight, regardless if the PV module is connected to or disconnected from the system.

(8) During installation, if PV modules are touched by bare hands, there is a risk of scalding or electric shock.

(9) Do not hit or put excessive load on the front or back of PV modules, this may break the cells or cause microcracks.

(10) Do not unplug the connector if the system circuit is connected to a load.

(11) Do not stand on the module glass. There is a risk of injury or electric shock if glass is broken.

(12) Do not work alone (always work as a team of 2 or more people).

(13) Do not damage the back glass of PV modules when fastening the PV modules to a support with bolts.

(14) Do not drill holes in the frame. It may cause corrosion of the frame or PV modules burst.

(15) Do not damage the surrounding PV modules or mounting structure when replacing a PV module.

(16) Cables should be fixed in the area not exposed to direct sunlight to prevent cables aging.

(17) Protective measures must be taken in the process of installation to avoid force extrusion or impact on the modules.

(18) When installing modules on roof mounted structures, please try to follow the “from top to bottom” and/or “from left to right” principle, and don’t step on the module. This will damage the module and would be dangerous for personal safety.

(19) The design loading of modules have been evaluated by TUV according to IEC61215 with 1.5 times safety factor; The mechanical load bearing is dependent upon the mounting methods used and failure to follow the instructions of this manual may result in different capabilities to withstand snow and wind loads;The system installer must ensure that the installation methods used meet these requirements and any local codes and regulations.

(20) Installation should be in accordance with Australian installation standards AS3000 wiring rules and AS/NZS 5033.

(21) We recommend that you insure your solar system against natural hazards (e.g. against lightning strikes).

5.2. ENVIRONMENT CONDITIONS AND SITE SELECTION

ZNSHINE SOLAR module should be installed in the following environmental conditions.

Table 5-1 operation condition

NO	Environmental conditions	Range
1	Recommended Working temperature	-20°C ~ +47°C
2	Extreme Working temperature	-40°C ~ +85°C
3	Storage temperature	-20°C ~ +50°C
4	Humidity	< 85RH%

Remarks: The working environment temperature is the monthly average maximum temperature and minimum temperature of the installation site. The mechanical load bearing capacity of the solar PV modules determined based on the installation method. The professional solar PV system installer must be responsible for calculating the solar PV system machinery when designing the solar PV system load bearing capacity.

If you are planning to use the PV modules where the water damage (Humidity: >85RH%) may be possible, please consult with ZNSHINE SOLAR technical support firstly to determine an appropriate installation method, or to determine whether the installation is possible.

The modules are certified according to the norm IEC 61215 and others for safe operation in moderate climates. The operator needs to consider the effect of the high altitude on the operation of the module, when the modules are installed at high altitude. The maximum altitude allowed for PV Module installation is 2000m.

For most places, PV modules should be installed where the sunlight can be maximally acquired throughout the year. In the Northern Hemisphere, the PV modules should typically face south, and in the Southern Hemisphere, the PV modules should typically face north.

When selecting the installation location, avoid areas with trees, buildings, or obstacles because these objects will form shadows on PV modules, especially when the sun is at the lowest position on the horizon in winter. The shadow will cause the loss of the output power of the solar photovoltaic system. Although the bypass diode installed in the PV module can reduce this loss to some extent, do not ignore the shadow factor.

Position the modules to minimize the chances of shading at all times of the day. Try to install modules in a location where there is rare shading throughout the year.

According to IEC 61701, salt mist corrosion testing of photovoltaic (PV), ZNSHINE SOLAR PV modules can be installed in corrosive salt areas within proximity of the ocean or sulfurous areas. The module must not be soaked in the water or in the environment (i.e., fountain, spindrift, etc.) where the module would touch water (pure water or brine) for a long term. If the modules are placed in an environment of salt fog (i.e., marine environment) or sulfur (i.e., sulfur sources, volcanoes, etc.), there is a risk of corrosion. It's not recommended to install the modules, when the distance is less than 100m ; and it's recommended to install the modules with the anti-salt function, when the distance is between 100m and 1km. So stainless steel or aluminum materials must be used to contact the PV modules, and the installation position must be processed with anti-corrosion treatment.

According to IEC62716 "Ammonia corrosion testing of photovoltaic (PV) modules", ZNSHINE SOLAR modules can be safely installed in ammonia-heavy environments, such as farm, meadow and so on.

According to the surrounding environment of the project, use the appropriate protective measures to ensure the safety of the module installation and reliable. For example, it needs to have around the windproof measures like design of windbreaks in strong wind area.

The system design needs to have the lightning protection function, it must pay more attention especially in the installation ground where are more lightning strike.

When installing modules on a roof, the roof must be covered with a layer of fireproof material applicable to

this class, and adequate ventilation must be ensured between the back of the module and the installation surface. A safe working area also must be left between the edge of the roof and the external edge of the solar array.

In the case of residential installations on the ground, modules must be installed following local regulations, e.g. using fence.

5.3. TILT ANGLE OF INSTALLATION

The installation of solar PV module string should be in the same orientation and the same installation angle. Different installation directions and installation angles will lead to the mismatches in current and voltage which is caused by different light absorption of different PV modules, this mismatch will cause the PV system power output loss.

The largest power will be generated When direct sunlight on solar PV module. For modules which are installed on the fixed brackets, the best installation angle should be selected to ensure the maximum power output can be generated at winter time, if the angle can guarantee enough power output during the winter, it will make the whole solar PV system in the rest of the year can have enough power output also.

PV modules are recommended to be installed at an optimized tilt angle to maximize the energy output. For detailed information on the best installation angle, please refer to standard solar photovoltaic installation guides or consult a reputable solar installer or systems integrator. Dust building up on the surface of the modules can impair module performance. ZNSHINE SOLAR recommends installing the modules with a tilt angle of at least 10°, making it easier for dust to be washed off by rain. Any faults caused by and/or attributable to tilt angle less than 10 degrees are not covered by manufacturer's warranty. It is roughly equal to the latitude of the project site as a rule of thumb, facing toward the equator. Optimized system designs must incorporate other local requirements.

Installation inclination refers to the Angle between the PV module and the ground plane, as shown in Figure 5-1.

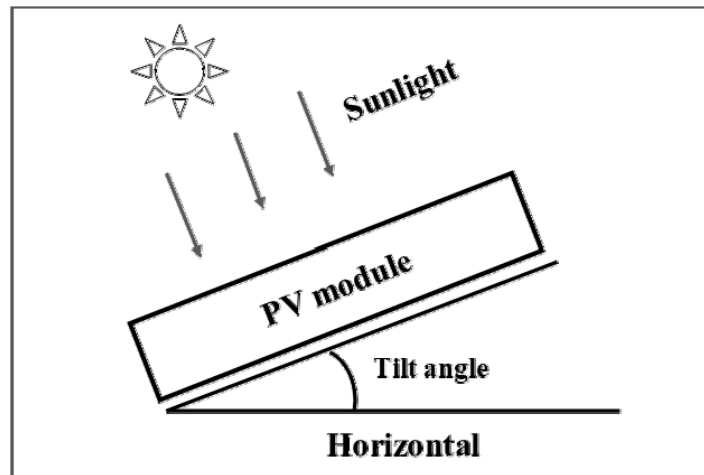

Fig. 5-1 Tilt angle

Table 5-2 Recommended tilt angle for fixed systems

Latitude	Tilt angle
0° ~ 15°	15°
15° ~ 25°	The same latitude
25° ~ 30°	Same latitude +5°
30° ~ 35°	Same latitude +10°
35° ~ 40°	Same latitude +15°
40°+	Same latitude +20°

5.4、INSTALLATION REQUIREMENTS FOR BIFACIAL CELLS MODULE

Under the certain installation conditions, the backside of bifacial cells module will also generate electricity power after receiving the reflected light, which will bring additional power generation gain to the power station system.

The shading on the module surface will affect the power generation much, the module should be installed in the place where the module cannot be shadowed totally (such as the shadow from building, chimney and tree etc.), and even the partially shading (such as the dirt, snow and aerial wire etc.) should be avoided.

The generation gain is related to the ground reflectivity, the module installation height to the ground, the array spacing and the shadow shading to the module backside.

Generally speaking, the reflectance is various with the different ground (See table 5-3), and this will lead to different power generation gain.

Table 5-3 reflectivity of different surfaces

The ground type	Water	Grassland	Ground	Concrete	Sand	Snow
Reflectivity range (%)	5-12	12-25	20-33	20-40	20-40	80-85

Due to the different ground clearance height will affect the power generation gain, it is recommended to install the module at a height from 0.5m to 2m. See Fig. 5-2.

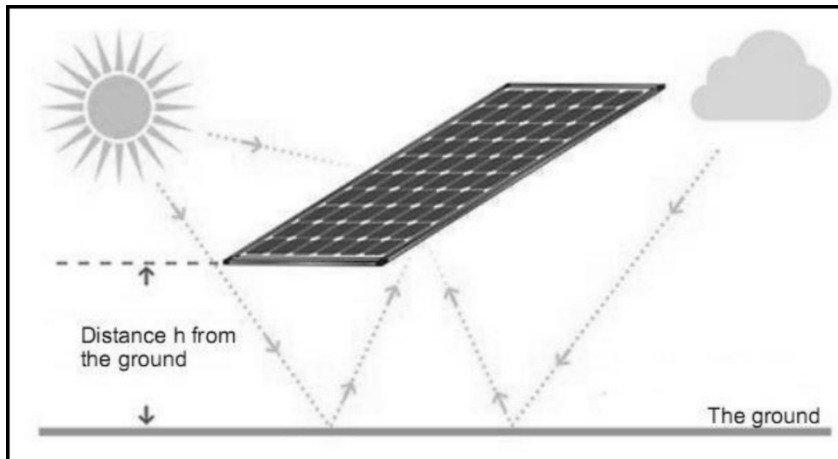

Fig. 5-2 Distance from the earth

In the system design, besides the ground type and the module installation height to ground, the proper array spacing and how to avoid shadow shading on the back need to be considered too, please consult with the professional system designer.

5.5、INSTALLATION METHOD

5.5.1 MECHANICAL INSTALLATION AND WARNING

PV modules can be installed through bolt method and clamp method. The modules must be installed according to the following examples and recommendations. If a different installation method is desired, please contact ZNSHINE SOLAR customer service or technical support team for consultation. Improperly mounted modules maybe damaged. If alternative mounting method is used that has not been approved by ZNSHINE SOLAR, the modules will not continue to carry a valid warranty.

Modules shall not be subjected to wind or snow loads which is exceeding the maximum permissible designed loads, and shall not be subjected to excessive forces due to the thermal expansion of the support structures. The selection and design of mounting bracket shall be carried out by professional system engineers after the load calculation according to the climatic conditions of the installation site.

The modules depicted are mounted on continuous rails that extend beneath the modules. If modules are

mounted without continuous rails below them, the maximum allowable loading will be reduced and needs to be subjected to review by ZNSHINE SOLAR.

Please ensure that the modules with the same color cells to be installed together.

A clearance of at least 115mm (recommended) is provided between modules and the surface of the wall or roof.

The minimum clearance between two adjacent modules must not be less than 10mm.

The module frame drain holes cannot be blocked in any situation during installation or use.

To maximize mounting longevity, ZNSHINE SOLAR strongly recommends the use of corrosion proof (stainless steel) attachment hardware.

Secure the module in each mounting location with an M8 bolt and a flat washer, spring washer and nut and tighten to a torque of 16~20 N.m(140-180lbf.in.). The tightening step is as follows :

- a. Use torque wrench to tighten nut to target torque: 16~20N.m;
- b. Nut loosen 90~180 degrees;
- c. Finally tighten the nut to the target torque and reduce the torque attenuation.

All parts in contact with the modules should use flat stainless steel washers of minimum 1.8mm thickness with an outer diameter of 20-24mm.(Except for Single-axis tracking system)

Flat stainless steel gaskets with a minimum thickness of 1.5mm and an external diameter of 16-20mm shall be used in all parts of the components connected to the Single-axis tracking system.

The installation method listed below are for your reference only, the PV system installer or the trained professionals should take the responsibility of the PV system design, mechanical load calculation, install, maintenance and safety, ZNSHINE SOLAR will not supply the related material for system installation.

Tools: screwdriver, wrench, stainless steel screw/bolt, clamp, nut and spring washer, plain washer.

A. Mounting with Bolts 4-φ9*14mm mounting holes, (Applicable to framed Double-glass and framed Bifacial double-glass)

Modules can be attached using the mounting holes 4-φ9*14mm on the back of the module frame, by fixing the module to the support rails with bolts. The mounting details are shown in the following figures.

The frame of each module has 8-φ9*14mm mounting holes, ideally placed to optimize the load handling capability, to secure the modules to the supporting structure. The middle four mounting holes are used for normal installation, as shown in Figure 5-3. It is recommended that you put the PV module vertically when you use the bolt to fix it, so that the module will not slide easily and use more safely.

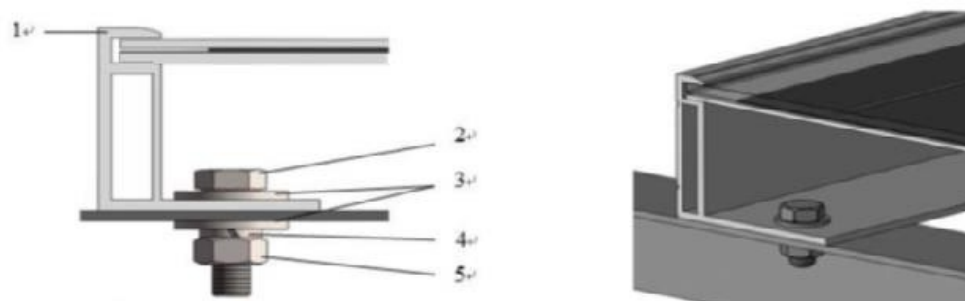
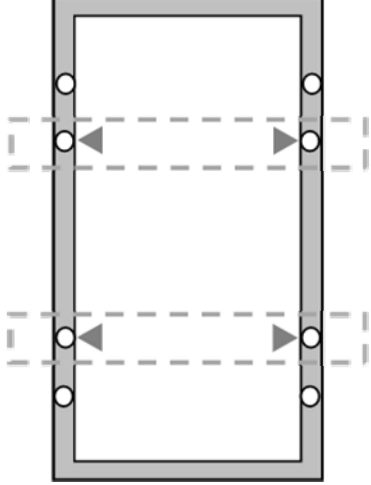
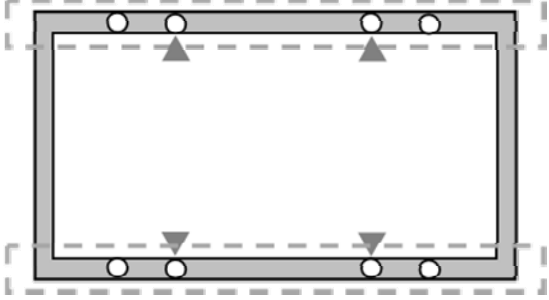

Fig.5-3 Double-glass module with frame

- | | |
|-------------------------|---------------------------|
| 1.aluminum frame | 2.M8 hex bolt M8 |
| 3.flat stainless washer | 4.spring stainless washer |
| 5.hex stainless nut | |

Module	Mechanical Load Pressure	Safety factor	Mounting Direction
60/66/72/120/132/144pcs Double-glass	+3600Pa/-1600Pa	1.5	 <p>*NOTE:</p> <ol style="list-style-type: none"> 1. The crossbeam is perpendicular to the long side. This installation may cause the cell covered, so ZNSHINE SOLAR does not recommend this installation for Framed Bifacial double-glass. 2. Need two support rails below the PV module to make sure the Mechanical load. 3. The load is an empirical value of a standard module based on a standard installation mode, and the specific information shall be consulted by ZNSHINE SOLAR.
60/66/72/120/132/144pcs Bifacial double-glass	+1600Pa/-1600Pa	1.5	 <p>*NOTE:</p> <ol style="list-style-type: none"> 1. The beam is parallel to the long side. 2. Need two support rails below the PV module to make sure the Mechanical load. 3. The load is an empirical value of a standard module based on a standard installation mode, and the specific information shall be consulted by ZNSHINE SOLAR.

B. Mounting with Single-axis Tracking System with 4-φ7*10mm mounting holes

Modules can be attached through the mounting holes 4-φ7*10mm on the back of the module frame, by fixing the module to the support rails with bolts. The mounting details are shown in the following figures.

The frame of each module has 4-φ7*10mm mounting holes, ideally placed to optimize the load handling capability, to secure the modules to supporting structure. 4 installation holes of 7*10 mm are used for Single-axis tracking system installation, as shown in Figure 5-4.

To maximize mounting longevity, ZNSHINE SOLAR strongly recommends the use of corrosion proof (stainless steel) attachment hardware.

Secure the module in each mounting location with an M6 bolt and a flat washer, spring washer and nut and tighten to a torque of 16~20 N.m(140-180lbf.in.).

The bolt should be made of stainless steel or the other anti-corrosion material.

Flat stainless steel gaskets with a minimum thickness of 1.5mm and an external diameter of 16- 20mm shall be used in all parts of the components connected to the Single-axis tracking system.

Mechanical Load Pressure under this method: 30 lbs.ft² max from the front side & 30 lbs.ft² max from the rear

according to UL1703.

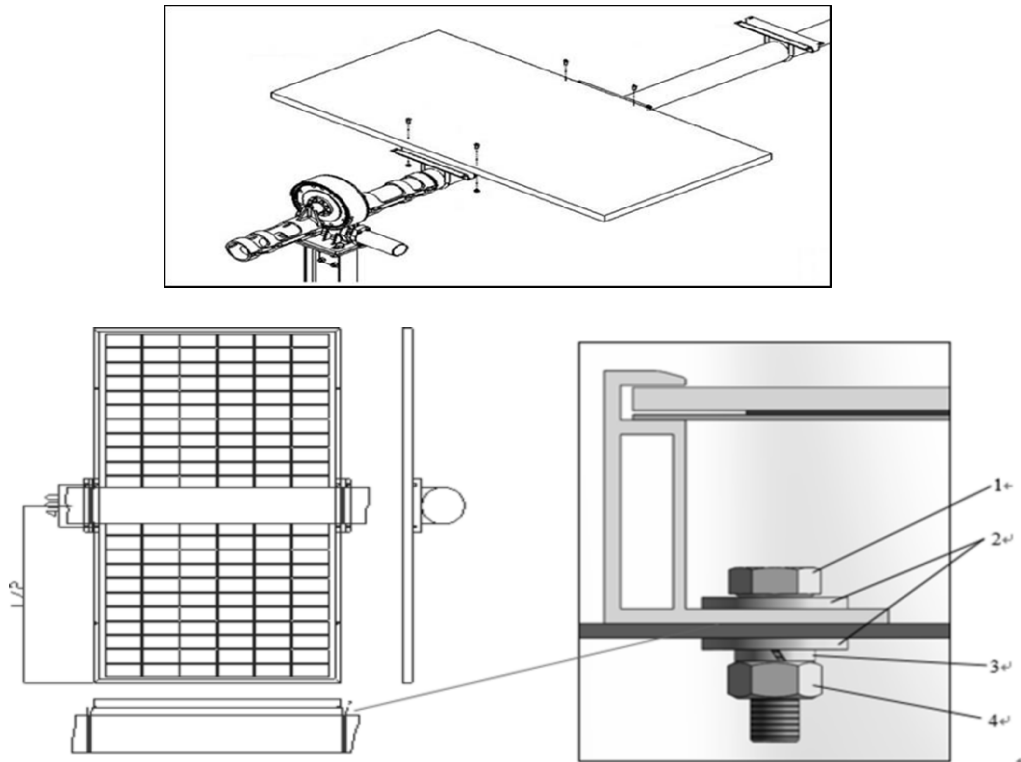

Fig 5-4: PV module installed with Single-axis Tracing System

- 1. M6 Stainless hex bolt M6
- 2. flat stainless washer
- 3. spring stainless washer
- 4. hex stainless nut

Module	Mechanical Load Pressure	Safety factor	Mounting Direction
60/66/72/120/132/144 pcs double-glass 60/66/72/120/132/144 pcs bifacial double-glass	+1600Pa /-1600Pa	1.5	

***NOTE:** The above-described distance is from the middle of the bolts to the middle of the bolts.

This installation may cause the cell covered, so ZNSHINE SOLAR does not recommend this installation for Framed bifacial double-glass.

The load is an empirical value of a standard module based on a standard installation mode, and the specific information shall be consulted by ZNSHINE SOLAR.

C. 2V Installation Method

The single module is installed with two $\phi 7*10\text{mm}$ mounting holes and two $\phi 9*14\text{mm}$ mounting holes, as shown in figure 5-5. The overall installation method is shown in the table below.

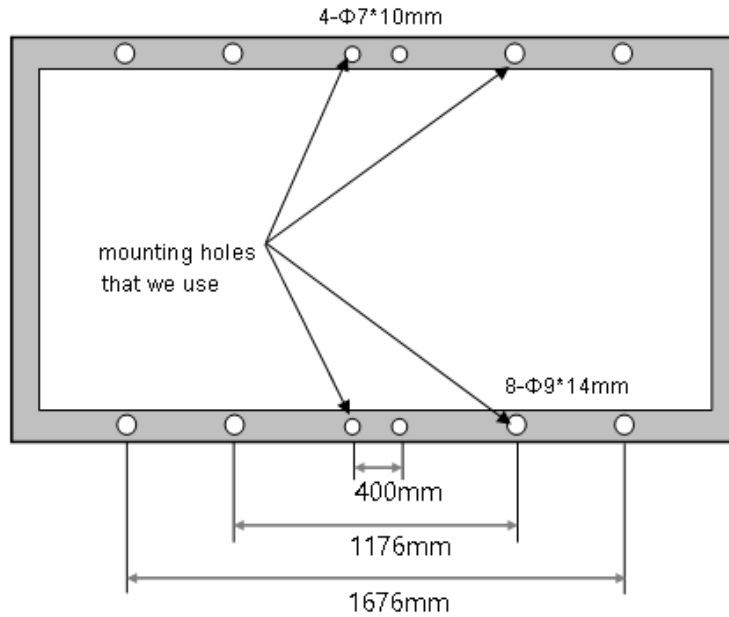

Figure 5-5: Mounting holes schematic of the single module for the 2V installation method

Module	Mechanical Load Pressure	Safety factor	Mounting Direction
60/66/72/120/132/144 pcs double-glass 60/66/72/120/132/144 pcs bifacial double-glass	+1600Pa /-1600Pa	1.5	

***NOTE:** The load is an empirical value of a standard module based on a standard installation mode, and the specific information shall be consulted by ZNSHINE SOLAR.

D. Mounting with Clamps applied for framed Double-glass and Bifacial double-glass

ZNSHINE SOLAR has tested its modules with a number of clamps from different manufacturers, with a mounting bolt of at least M8. The length of clamp $\geq 80\text{mm}$, thickness $\geq 3\text{mm}$. If the customer needs a different size of clamps, it should be fully evaluated and approved by ZNSHINE SOLAR.

The clamp must overlap the module frame by at least 7mm but no more than 10mm.

Use at minimum 4 clamps to attach modules to the mounting rails.

Modules clamps should not come into contact with the front glass and must not deform the frame.

Be sure to avoid shadowing effects on the solar cells from the module clamps.

The module frame is not to be modified under any circumstances.

When choosing this type of clamp-mounting method, use at least four clamps on each module, two clamps should be attached on each long sides of the module (for portrait orientation) Depending on local wind and snow loads, additional clamps may be required to ensure that modules can bear the load.

Applied torque should refer to mechanical design standard according to the bolt customer is using, ex: M8 16-20N.m(140-180lbf.in)

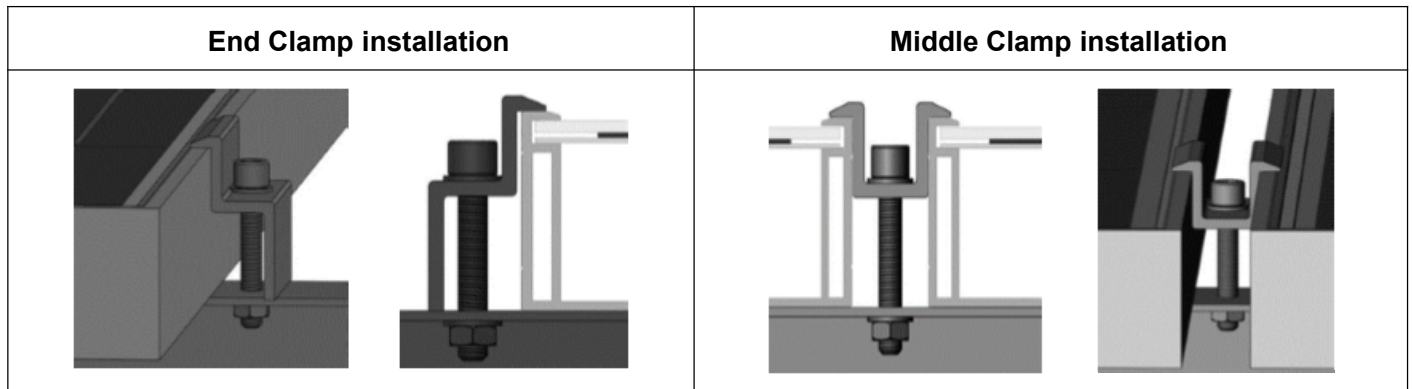

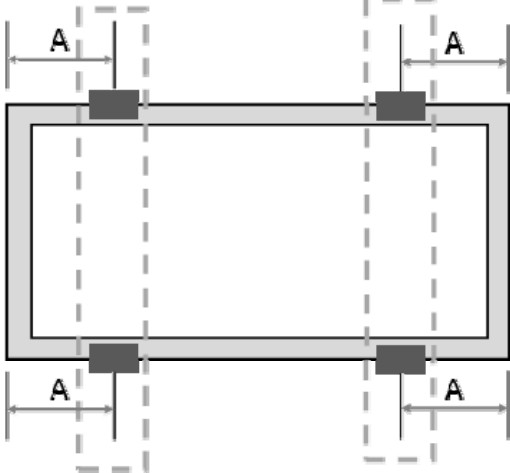
Module	Mechanical Load Pressure	Safety factor	Mounting Direction
60/66/72/120/132/144pcs double-glass	+3600Pa/-1600Pa	1.5	 <p style="text-align: center;">$A = 1/4L \pm 50\text{mm}$; L=Module length</p> <p>*NOTE:</p> <ol style="list-style-type: none"> 1. The crossbeam is perpendicular to the long side. This installation may cause the cell covered, so ZNSHINE SOLAR does not recommend this installation for Framed Bifacial double-glass. 2. The above described distance is from the module edge to the middle of the clamp. Clamps length $\geq 80\text{mm}$. 3. Need two support rails below the PV module to make sure the Mechanical load. 4. The load is an empirical value of a standard module based on a standard installation mode, and the specific information shall be consulted by ZNSHINE SOLAR.

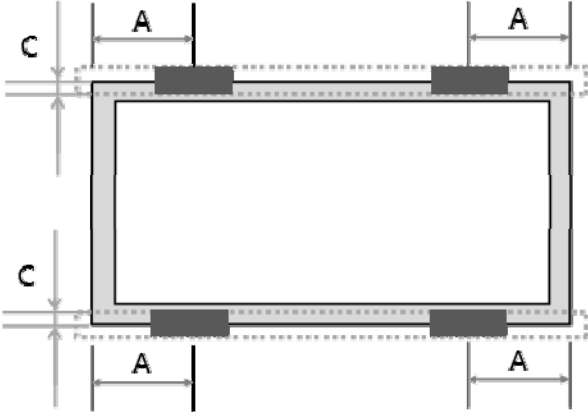
<p>60/66/120/132pcs double-glass</p>	<p>+1600Pa/-1050Pa</p>	<p>1.5</p>	 <p>$A=1/5L\pm 50\text{mm}$; $L=\text{Module width}$</p> <p>*NOTE:</p> <ol style="list-style-type: none"> 1. The crossbeam is perpendicular to the short side frame. This installation may cause the cell covered, so ZNSHINE SOLAR does not recommend this installation for Framed Bifacial double-glass. 2. The above described distance is from the module edge to the middle of the clamp. Clamps length $\geq 80\text{mm}$. 3. Need two support rails below the PV module to make sure the Mechanical load. 4. The load is an empirical value of a standard module based on a standard installation mode, and the specific information shall be consulted by ZNSHINE SOLAR.
<p>60/66/72/120/132/144pcs bifacial double-glass</p>	<p>+1600Pa/-1600Pa</p>	<p>1.5</p>	 <p>$A=1/4L\pm 50\text{mm}$; $C=10\pm 2\text{mm}$; $L=\text{Module length}$</p> <p>*NOTE:</p> <ol style="list-style-type: none"> 1. The beam is parallel to the long side. 2. The above described distance is from the module edge to the middle of the clamp. Clamps length $\geq 80\text{mm}$. 3. Need two support rails below the PV module to make sure the Mechanical load. 4. The load is an empirical value of a standard module based on a standard installation mode, and the specific information shall be consulted by ZNSHINE SOLAR.

E. Mounting with Clamps apply to Frameless Double-glass and Frameless Bifacial double-glass

ZNSHINE SOLAR has tested its modules with a number of clamps from different manufacturers and recommends the use of clamps which have an EPDM or similar insulating washer, with a mounting bolt of at least M8.

Use at minimum 4 clamps to attach modules o the mounting rails.

Be sure to avoid shadowing effects on the solar cells from the module clamps.

When choosing this type of clamp-mounting method, use at least four clamps on each module, the 4 clamps should be attached two each on the long sides of the module. Depending on local wind and snow loads, additional clamps may be required to ensure that modules can safely bear the load. The clamps of double-glass and bifacial double-glass are different because backside to be used with the Bifacial double-glass cannot be shaded. ZNSHINE clamps are recommended for the Bifacial double-glass.

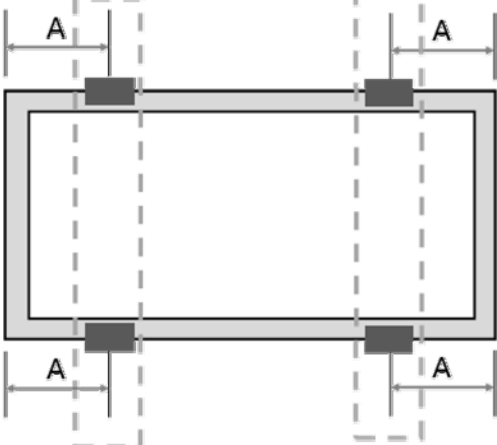
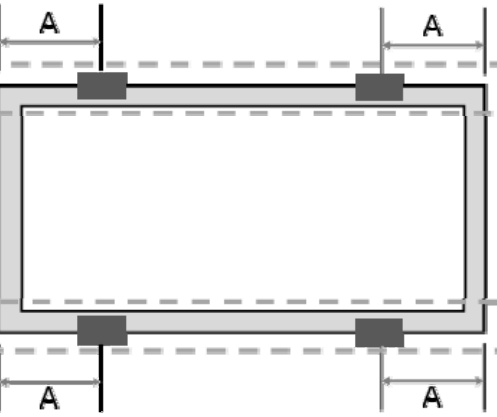
Module	Mechanica Load Pressure	Safety factor	Clamp Length	Mounting Direction
60/66/120/132 pcs frameless double-glass	+3600Pa/-1600Pa	1.5	150mm	 <p data-bbox="1018 1144 1469 1178">$A=1/4L\pm 50\text{mm}; L=\text{Module length}$</p>
60/66/120/132 pcs frameless bifacial double-glass	+1600Pa/-1600Pa	1.5	150mm	 <p data-bbox="1018 1630 1469 1664">$A=1/4L\pm 50\text{mm}; L=\text{Module length}$</p>

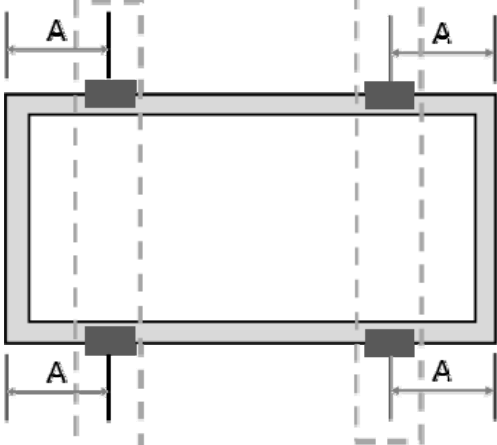
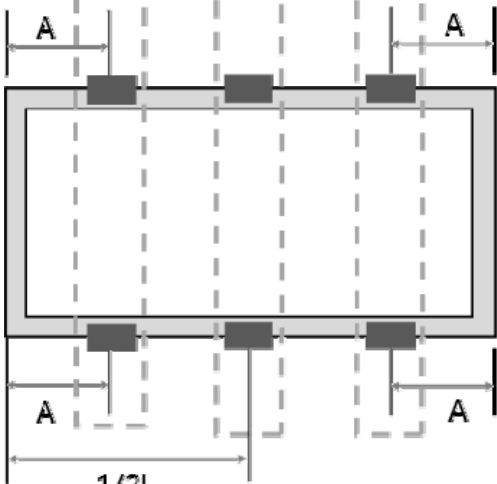
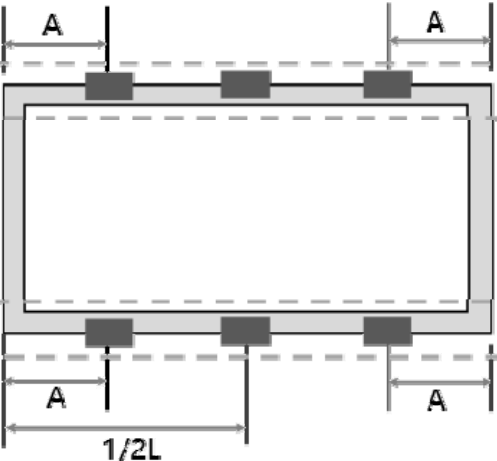
72/144 pcs frameless double-glass	+1600Pa/-1600Pa	1.5	150mm	 <p>$A=1/4L\pm 50\text{mm}$; $L=\text{Module length}$</p>
72/144 pcs frameless double-glass	+3600Pa/-1600Pa	1.5	150mm	 <p>$A=1/4L\pm 50\text{mm}$; $L=\text{Module length}$</p>
72/144 pcs frameless bifacial double-glass	+1600Pa/-1600Pa	1.5	150mm	 <p>$A=1/4L\pm 50\text{mm}$; $L=\text{Module length}$</p>

***NOTE:** The above-described distances are from the module edge to the middle of the clamp.

Need two or more support rails below the PV module to ensure the mechanical load.

The load is an empirical value of a standard module based on a standard installation mode, and the specific information shall be consulted by ZNSHINE SOLAR.

STEP 1: Remove the connector parts

Remove the bottom connector parts.

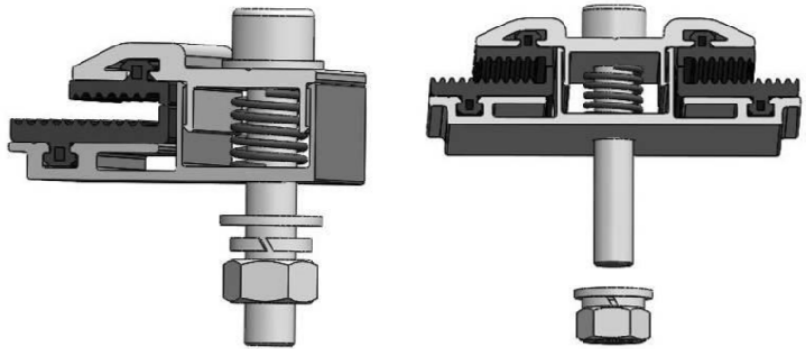

STEP 2: Install the clamp

Put the clamp bolts into the installation holes, and then tighten the nuts. Maintain the distance between two clamps used to install the PV modules about 1m.

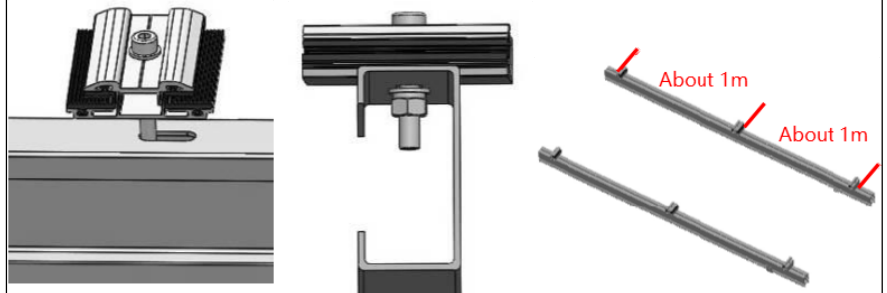

STEP 3: Install the PV modules

Insert the PV module into the clamp, and make sure the module edge touch to the EPDM closely and then tighten the nut with uniform torque values using a q qualified torque wrench. Ensure the module is firmly secured.

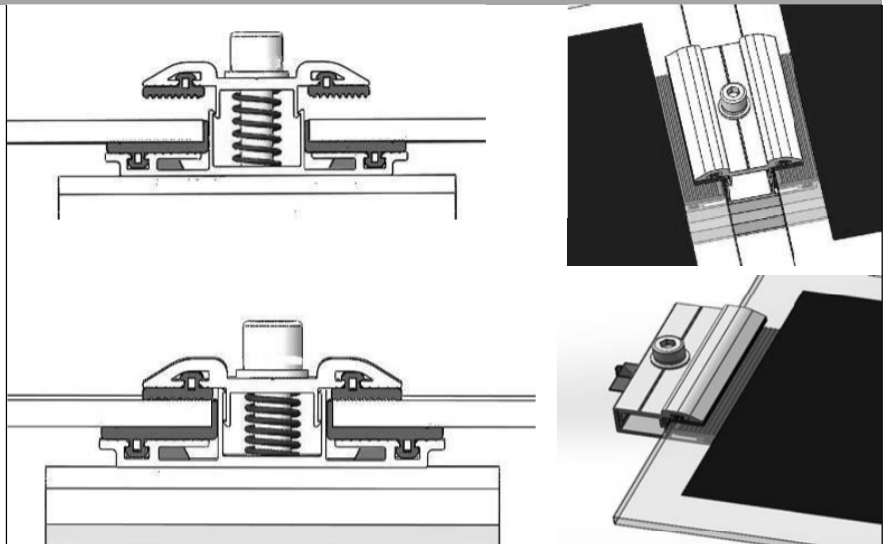

***NOTES:**

Other mounting configurations can be used. However, failure to comply with the above recommendations will result in a lowering of the load handling capabilities below the empirical value, and product failure as a result of an overload situation will not be covered by the ZNSHINE SOLAR warranty.

5.5.2 ELECTRICAL INSTALLATION

The modules use the PV-JX1203、PV-JX1203B、PV-JX1203X (X=C or D)、PV-HT021、PV-HT021-2 type junction boxes. These boxes, on the back side of the module, is weatherproof and is designed to be used with standard wiring or conduit connections. Wiring methods should be in accordance with the NEC (National Electrical Code). Bypass diodes and cable clamps are included with each module when shipped from the factory.

1、Cable layout

The recommended vertical installation connection methods for module with split J-Box are as follows (The extension cable is required).

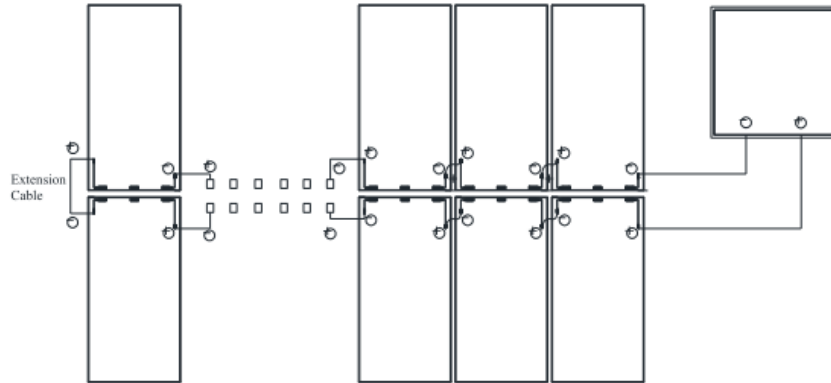

Fig.1 Split J-Box at module side position for vertical direction

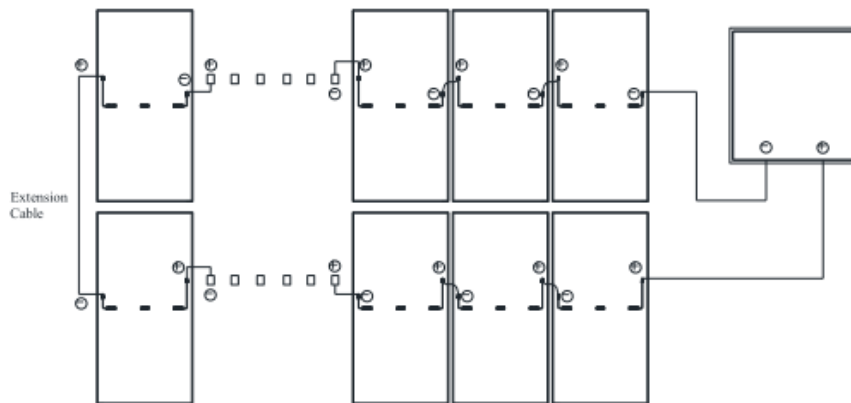

Fig.2 Split J-Box at module middle position for vertical direction

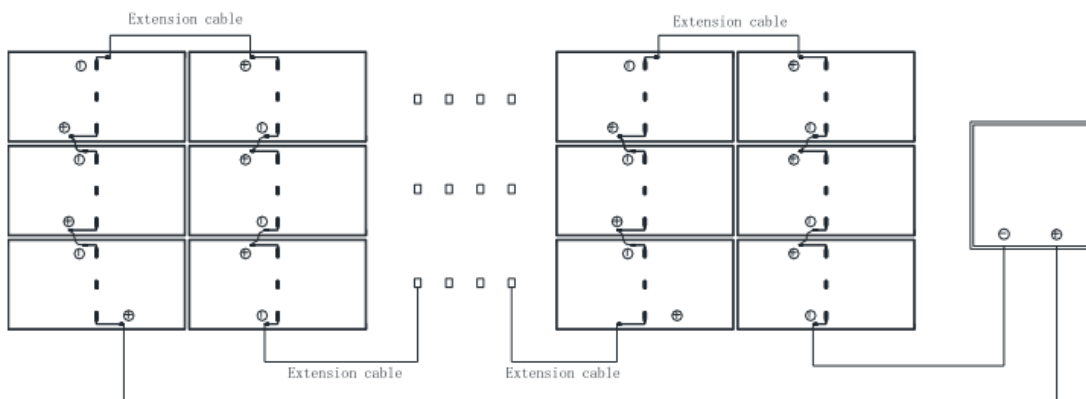

Fig.3 Split J-Box at module middle position for horizontal direction

Precautions: To minimize risk in the event of an indirect lightning strike, avoid forming loops when designing the system. In order to avoid bad or damaged connection of the cable and connector, the cable and junction box caused by human factors, affecting the electrical safety or service life of the product, it is recommended that the force applied between the cable and connector, cable and junction box shall not be greater than 60N during the installation, dismantling, maintenance and any other related process of the Product.

Pay attention to the direction of the wire when installing the modules. It should be connected along the wire direction to avoid bending the wire.

2、Electrical Connection

The Direct Current (DC) generated by the PV system can be converted to Alternating Current (AC) and connected to the public power grid. Different regions may have different policies, laws and regulations to stipulate the installation and grid-connection requirements of PV systems. Therefore, during the design, installation and grid-connection of PV system, please comply with the local policies, laws and regulations.

PV modules can obtain different current and voltage outputs through series connection and parallel connection. Read this installation manual carefully before electrical connection and installation. Please design and connect according to the current and voltage required by customers. Before connection, please ensure that the connection part is free from corrosion, and keep it clean and dry.

Different types of modules cannot be connected in series. Modules connected in series should ensure the consistency of their current. The voltage of the module string should not exceed the allowable system voltage value, which can be found on the nameplate or datasheet of the module.

ZNSHINE SOLAR modules are provided with stranded copper cables with a cross sectional area of 4mm² which are UV resistant. All other cables used to connect the DC system should have a similar (or better) specification.

The maximum number of modules in series depends on the system design, the type of converter used and the environmental conditions. In general, the maximum number (N) of PV modules in series can be calculated by dividing the maximum system voltage by the open circuit voltage of the relevant solar PV modules. When designing the solar PV system, it is necessary to take into account the characteristic that the voltage of the solar PV module changes with the temperature. Considering the voltage increase caused by temperature drop in extreme environment in winter, the maximum series connection number of solar PV modules can be calculated by the following formula.

Table 5-4 maximum series connection number calculation

Formula	Maximum system voltage $V \geq N * V_{oc} * [1 + \beta * (T_{min} - 25)]$
V	Maximum system voltage
N	The number of maximum solar PV modules in series
V_{oc}	The open circuit voltage of each module (see product label or datasheet)
β	Temperature coefficient of open circuit voltage of the module (refer to datasheet)
T_{min}	The lowest ambient temperature at installation site

If the modules are allowed to be installed in parallel electrically, each module (or series string of modules so connected) shall be provided with the maximum series fuse as specified. For applications requiring high currents, several photovoltaic modules can be connected in parallel; the total current is equal to the sum of individual currents, each module (or series string of modules so connected) shall be provided with the maximum series fuse as specified. The recommended number of module in parallel is only one. The modules' electrical performance in a system is the same. When connected in series, all modules must have the same amperage. When connected in parallel, the modules must all have the same voltage. Connect the quantity of modules that match the voltage specifications of the devices used in the system. The modules must not be connected together to create a voltage that is higher than the permitted system voltage.

Product can be irreparably damaged if an array string is connected in reverse polarity to another. Always verify the voltage and polarity of each individual string before making a parallel connection. If you measure a reversed polarity or a difference of more than 10V between strings then check the string configuration before making the connection.

Before wiring the module, ensure that the contact points are corrosion resistant, clean and dry; If a string of modules is reversed, irreparable damage can be caused.

Each ZNSHINE SOLAR PV module has two PV cables which can withstand 85°C temperature and they are sunlight resistant(UV). The cross-sectional area of the cable is 4mm² or 12AWG, and the external diameter is 5mm~7mm. The minimum bending radius of the cables must be 43mm. Any cable damage caused by bending too much or cable management system is not covered under ZNSHINE SOLAR's warranty. Plug & Play connectors are included at the end of each cable. All other cables used to connect the direct current system shall

have similar (or higher) specifications, and should have the suitable insulation ability which can suffer the possible maximum system V_{oc} (as defined in TUV 2PFG1169 or EN50618 (H1Z2Z2-K)). ZNSHINE SOLAR requires all cables and electrical connections to comply with the electrical regulations of the countries where the PV system is installed.

The electrical characteristics are within ± 3 percent of the indicated values of I_{sc} , V_{oc} and P_{mpp} under test conditions (irradiance of $1000W/m^2$, AM1.5 spectrum, and a cell temperature of $25^{\circ}C$)

Under normal conditions, a PV module is likely to experience conditions that produce higher current and/or voltage than reported at standard test conditions. Accordingly, the values of I_{sc} and V_{oc} . marked on this PV module should be multiplied by a factor of 1.25 at least when determining component voltage ratings, conductor current ratings, and size of controls (e.g. inverter) connected to the PV output.

When selecting a cable, the minimum current-carrying capacity of the cable can be calculated by the following formula.

$$\text{Minimum current-carrying capacity of the cable} = 1.25 * I_{sc} * N_p$$

I_{sc} : short-circuit current of PV module (unit: A)

N_p : the number of modules in parallel or module strings

If the module is connected to the control box, you must choose the control box with LJQ-1、LJQ-3、PV-HT03 type Connectors. To ensure proper system operation the correct cable connection polarity (Figures 1 & 2) should be observed when connecting the modules to each other or to a load, such as inverter, a battery etc. If modules were not connected correctly, the bypass diodes could be destroyed. PV modules can be wired in series to increase voltage. A series connection is made when the wire from the positive terminal of one module is connected to the negative terminal of the next module. A parallel connection is made when the wire from the positive terminal of one module is connected to the positive terminal on the next module. Do not connect Fuse in Combiner Box with two or more strings in parallel connection.

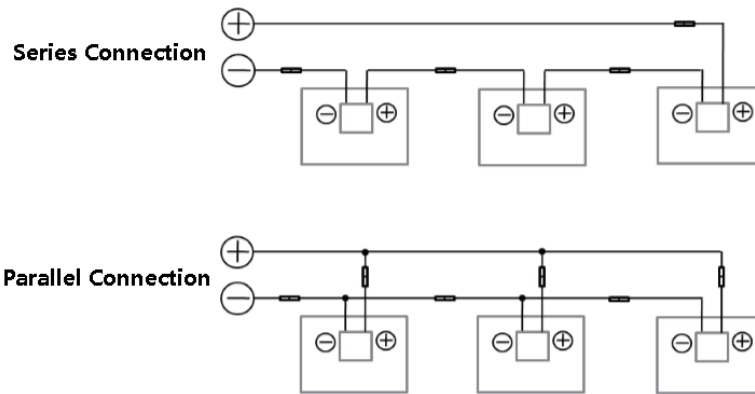

Fig 1

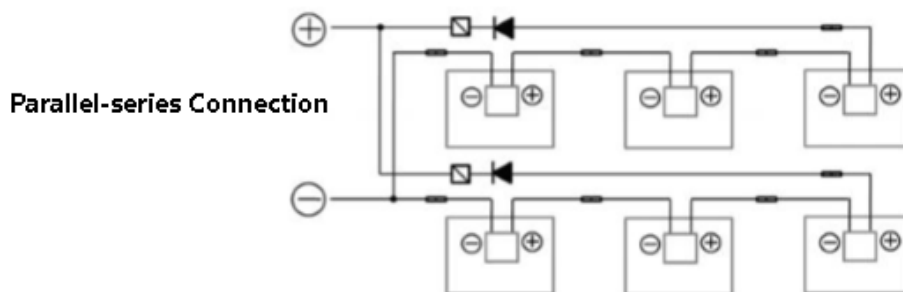

Fig 2

The number of modules in series and in parallel shall be designed reasonably according to the system configuration.

To clear or trim excess cables and ZNSHINE SOLAR recommends that all cables be placed in proper pipework and away from standing water.

ZNSHINE SOLAR recommends using lightning protection devices which are complied with local laws and electrical regulations.

All the above instructions must be followed to meet ZNSHINE SOLAR warranty conditions.

3. Bypass secondary

If PV module part by shadow block, which can lead to reverse voltage related to solar cells, PV modules in other unaffected battery string or other PV modules in the system and current will force through keep out part of the power loss and heat affected cell. When the PV module is connected in parallel with the bypass diode, the current in the system will flow directly through the diode, so as to bypass the blocked part of the PV module and minimize the heating degree and power consumption of the PV module.

Each module has three diodes. Please do not try to open the junction box to replace the diode, or even when the diode problem, please do this work by professionals.

4. Grounding

All PV module frames and mounting brackets must be properly grounded in accordance with the applicable national electrical code.

Correct grounding is achieved by continuously connecting the PV module frame and all metal modules together using the appropriate grounding conductor. The grounding wire may be copper, copper alloy or other materials that can be used as conductors and meet the requirements of the national electrical code. It is recommended to use the copper wire (4-14mm² or AWG 6-12) as the grounding wire. The signal "⏏" can be found at the grounding hole position. The ground wire must also be connected to ground through a suitable ground electrode. The tight connection of all the joint point should be ensured.

On a grounding hole with a diameter of $\phi 4$ mm, use a separate grounding wire and related accessories to connect the aluminum frame of the solar PV module and connect the grounding wire to the ground. The grounding uses the M4*12mm bolts and M4 nuts, star washers and plain washers, this ensures that the modules are firmly grounded. You can find the corresponding product drawing in module datasheet to know the detailed number, size and position of the grounding holes. The torque applied to ground fixation is 4N·m~8N·m.

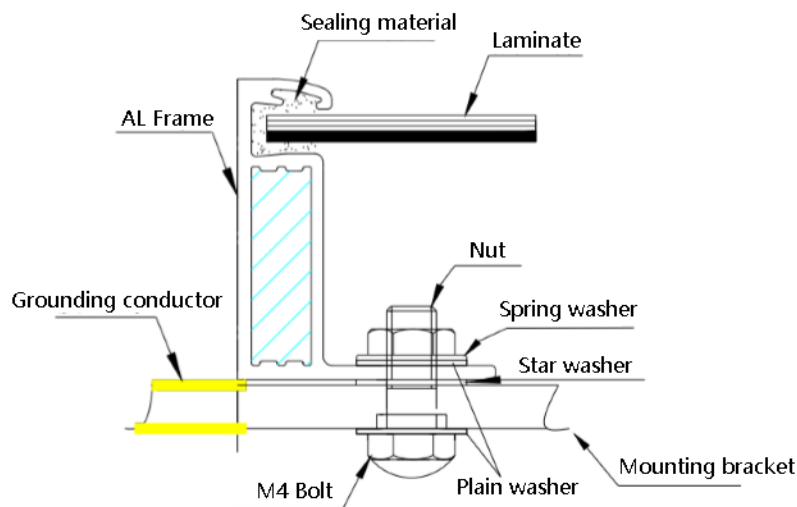

Grounding

When grounding, each module can be grounded directly or in series or in parallel. If you choose the latter two options, it is recommended that the maximum number of modules connected in parallel should not exceed four, and in series should not exceed eight.

In addition to use the grounding hole, you can also choose the following grounding ways:

- (1) Grounding by unused mounting holes
- (2) Other professional grounding devices

The electrical contact points of all the above grounding methods should penetrate the anodized film of the aluminum frame. PV modules can be grounded by other grounding devices, which must be reliable and certified. The manufacturer's requirements should be followed.

6、MODULE MAINTENANCE

In order to ensure the long-term using of the installed PV system and maximize the Power output performance of the modules, the installed PV modules need to be inspected and maintained regularly. The inspection and maintenance of modules in the PV array shall be carried out by personnel who have received professional PV system maintenance training and obtained relevant qualifications and authorization.

6.1、PANEL VISUAL INSPECTION AND REPLACEMENT

The modules in a PV array should be regularly checked for damage. Factors such as glass breakage, cable breakage, junction box damage and the terminals cannot be connected well may lead to function and safety problems. In the case of a damaged module, replace it with the same type of module. Do not touch live parts of cables and connectors. Use appropriate safety equipment (insulated tools, insulating gloves, etc.) when handling modules. Refer to the appropriate Product Installation Manual for installation and disassembly of module.

Check the electrical, grounding and mechanical connections every 6 months to ensure they are clean and safe, free from damage or rust. Check that all string fuses in each non/earthed pole are operating. Check that the mounting parts are tight. Check all cables and make sure that the connectors are securely. PV modules frames and bracket should be well mechanically connected.

Check whether there is any foreign body on the surface of the PV modules and whether there is any shielding. Trim any vegetation which may shade the PV array, thus impacting performance.

When repairing PV modules, cover the surface of PV modules with opaque material to prevent electric shock. Exposure of PV modules to sunlight will generate high voltages, this is dangerous. Please pay attention to safety when maintenance and it must be done by professionals.

Wear cut resistant gloves and other personal protective equipment required for the particular installation. Isolate the impacted array string to prevent current flow before attempting to remove the module. Disconnect the connectors of the affected module using the related disconnect tool provided by suppliers. Replace the damaged module with a new functional module of the same type.

In a system using a battery, blocking diodes are typically placed between the battery and the PV module output to prevent battery discharge at night.

When the irradiance is no less than $200\text{W}/\text{m}^2$, if the terminal voltage is more than 5% different than the rated value, it illustrates the connection of the modules is not good.

Comply with maintenance instructions for all modules used in the PV system, such as brackets, charging rectifiers, inverters, batteries, lightning protection systems, etc.

Warning: The warning signs on the PV modules must not be lost. Any electrical maintenance must shut down the PV system firstly. Improper system maintenance may cause fatal dangers such as electric shock and burning. Observe the safety precautions listed earlier in this Manual.

6.2、CONNECTOR AND CABLE INSPECTION

It's recommended to implement the following preventive maintenance every 6 months:

- (1) Check the sealing gels of the junction box for any damage.
- (2) Examine the PV module(s) for signs of deterioration. Check all wiring for possible rodent damage, weathering and that all connections are tight and corrosion free. Check electrical leakage to ground.
- (3) Inspect all cables to verify that connections are tight, the cables are protected from direct sunlight and sited away from areas of water collection.
- (4) Check the torque of terminal bolts and the general condition of wiring. Also, check that mounting hardware is properly torqued. Loose connections will result in damage to the array.

6.3、CLEANING

Dust accumulation on the glass surface of the module will reduce its power output and may cause hot spots. So the surface of PV modules should be kept clean. Maintenance work should be performed at least once six months or frequently.

Warning: It should be carried out by trained personnel. Workers should wear PPE, such as goggles, electric insulation gloves and safety shoes. The gloves should withstand DC voltages of no less than 2000V.

Use dry or wet soft cloths, sponges, etc. to clean the modules during the cleaning process, but do not put any modules directly into the water, do not use corrosive solvents and do not wipe the PV modules with hard objects. When the pressure water is used, the water pressure on the glass surface of the module must not exceed 700 KPa. The module must not be subjected to additional external force. If there is greasy dirt and other substances on the surface of the PV module which are difficult to clean, conventional household glass cleaning agents can be used; Do not use the alkaline and strong acid solvents. If necessary, use isopropyl alcohol (IPA) or other solution according to the safety instructions to clean and ensure that no solution flows into the gap between the edge of the module and the module frame.

Clean PV modules when the irradiance is below 200W/m². When cleaning the modules, use a soft cloth together with a mild detergent and clean water. Take care to avoid severe thermal shocks which might damage the module by cleaning modules with water which has a similar temperature to the modules being cleaned. For example, do not use cold water to clean the module when the temperature of it is high during the day, otherwise there will be the risk of module damage.

It is forbidden to clean PV modules under the weather conditions of wind more than 4 grades, heavy rain or heavy snow.

When cleaning PV modules, Do not step on the modules; Do not spray water on the backside of the module or the cables; keep the connectors clean and dry; prevent fire and electrical shock from occurring; Do not use as steam cleaner.

The back surface of the module normally does not need to be cleaned but, in the event this is deemed necessary, avoid the use of any sharp projects that might damage the penetrating the substrate material.

When cleaning the back surface of the module, take care to avoid penetrating the substrate material. Modules that are mounted flat (0° tilt angle) should be cleaned more often, as they will NOT "self-clean" as effectively as modules mounted at a 10° tilt or greater.

Do not scrape or grind stains off surfaces while PV modules are dry, as this can cause minor scratches on the surface.

Water requirements when cleaning:

- (1) PH: 5~7;
- (2) Chloride or salt content: 0 - 3000 mg/L
- (3) Turbidity: 0-30 NTU
- (4) Conductivity: 1500~3000 μ s/cm
- (5) Total dissolved solids: \leq 1000 mg/L
- (6) Water hardness: 0-40 mg/L
- (7) Non-alkaline water must be used, and softened water can be used when conditions permitted.

6.3.1 MODULE INSPECTION AFTER CLEANING

- (1) Ensure that the module under visual inspection is clean, bright and free of stains;
- (2) Spot check to verify whether there is soot deposit on the module surface;
- (3) Check to whether there are visible scratches on the surface of the module or not;
- (4) Check whether there is no man-made cracks on the module surface or not;
- (5) Check whether the module support structure is leaning or bent or not;
- (6) Check whether the connectors of the module are detached or not;
- (7) After cleaning, fill out the PV module cleaning record.

6.3.2 TROUBLESHOOTING

If the PV system does not work properly, please inform your installer immediately. It is recommended to perform a preventive inspection every six months, please don't change any modules of the modules. If electrical or mechanical properties are required for inspection or maintenance, qualified professionals should be advised to avoid any electric shock or loss of life.

7、SPECIFICATION FOR SOLAR MODULE BARCODE

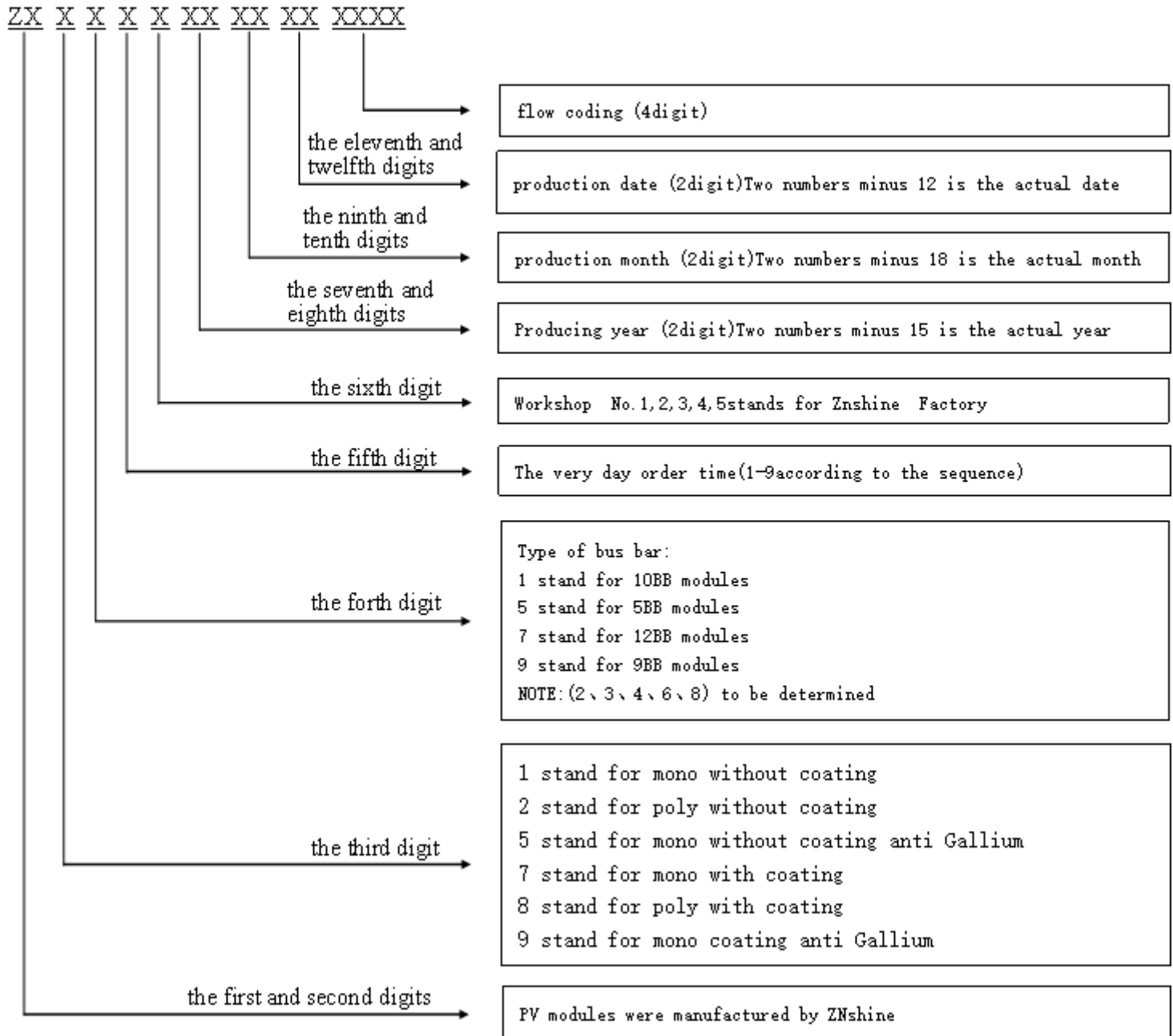

Example: PMC placed the order for the second time in one day, the 3rd workshop produced a batch of 5BB mono with coating PV modules. And the 3rd workshop started production on January 8, 2020, the barcode should be ZX7523351920xxxx.

8. TECHNICAL DATA

Specifications are subject to change without notice.

Mechanical And Electrical Ratings under STC

Module Type	Maximum Power Pmax <W>	Operating voltage Vmp <V>	Operating current Imp <A>	Open Circuit Voltage Voc <V>	Short Circuit Current Isc <A>	Overall Dimension <mm>	Weight <kg>	Module Series	Cell Size <mm>	Max. Series Fuse Rating <A>	MAX System voltage <V>	Application class
ZXM6-LD60-280/M	280	31.5	8.89	38.8	9.37	1658×992×25/30/35/40	21/21.5/22/22.5	Si Mono	156.75*156.75	15	1500	Class A
ZXM6-LD60-285/M	285	31.7	9.00	39.0	9.47	1658×992×25/30/35/40	21/21.5/22/22.5	Si Mono	156.75*156.75	15	1500	Class A
ZXM6-LD60-290/M	290	31.9	9.10	39.2	9.56	1658×992×25/30/35/40	21/21.5/22/22.5	Si Mono	156.75*156.75	15	1500	Class A
ZXM6-LD60-295/M	295	32.1	9.19	39.4	9.66	1658×992×25/30/35/40	21/21.5/22/22.5	Si Mono	156.75*156.75	15	1500	Class A
ZXM6-LD60-300/M	300	32.3	9.29	39.6	9.75	1658×992×25/30/35/40	21/21.5/22/22.5	Si Mono	156.75*156.75	15	1500	Class A
ZXM6-LD60-305/M	305	32.6	9.36	39.8	9.85	1658×992×25/30/35/40	21/21.5/22/22.5	Si Mono	156.75*156.75	15	1500	Class A
ZXM6-LD60-310/M	310	32.8	9.46	40.0	9.95	1658×992×25/30/35/40	21/21.5/22/22.5	Si Mono	156.75*156.75	15	1500	Class A
ZXM6-LD72-350/M	350	38.6	9.07	47.3	9.57	1978×992×25/30/35/40	25/25.5/26/26.5	Si Mono	156.75*156.75	15	1500	Class A
ZXM6-LD72-355/M	355	38.8	9.15	47.5	9.65	1978×992×25/30/35/40	25/25.5/26/26.5	Si Mono	156.75*156.75	15	1500	Class A
ZXM6-LD72-360/M	360	39.0	9.24	47.6	9.80	1978×992×25/30/35/40	25/25.5/26/26.5	Si Mono	156.75*156.75	15	1500	Class A
ZXM6-LD72-365/M	365	39.2	9.32	47.9	9.83	1978×992×25/30/35/40	25/25.5/26/26.5	Si Mono	156.75*156.75	15	1500	Class A
ZXM6-LD72-370/M	370	39.4	9.40	48.1	9.90	1978×992×25/30/35/40	25/25.5/26/26.5	Si Mono	156.75*156.75	15	1500	Class A
ZXM6-LD72-375/M	375	39.6	9.47	48.3	9.97	1978×992×25/30/35/40	25/25.5/26/26.5	Si Mono	156.75*156.75	15	1500	Class A
ZXM6-LD60-315/M	315	33.0	9.55	40.2	10.05	1678×1002×25/30/35/40	21.5/22/22.5/23	Si Mono	158.75*158.75	20	1500	Class A
ZXM6-LD60-330/M	330	33.6	9.83	40.8	10.35	1678×1002×25/30/35/40	21.5/22/22.5/23	Si Mono	158.75*158.75	20	1500	Class A
ZXM6-LD72-380/M	380	39.8	9.55	48.5	10.07	2000×1002×25/30/35/40	25.5/26/26.5/27	Si Mono	158.75*158.75	20	1500	Class A
ZXM6-LD72-385/M	385	40.0	9.63	48.7	10.14	2000×1002×25/30/35/40	25.5/26/26.5/27	Si Mono	158.75*158.75	20	1500	Class A
ZXM6-LD72-390/M	390	40.2	9.71	48.9	10.21	2000×1002×25/30/35/40	25.5/26/26.5/27	Si Mono	158.75*158.75	20	1500	Class A
ZXM6-LD72-395/M	395	40.4	9.78	49.1	10.28	2000×1002×25/30/35/40	25.5/26/26.5/27	Si Mono	158.75*158.75	20	1500	Class A
ZXM6-HD120-315/M	315	33.3	9.46	40.0	10.00	1696×1002×6	22.5	Si Mono	158.75*79.375	20	1500	Class A
ZXM6-HD120-330/M	320	33.5	9.56	40.2	10.09	1696×1002×6	22.5	Si Mono	158.75*79.375	20	1500	Class A
ZXM6-HLD120-315/M	315	33.3	9.46	40.0	10.00	1696×1002×25/30/35/40	21.5/22/22.5/23	Si Mono	158.75*79.375	20	1500	Class A
ZXM6-HLD120-330/M	320	33.5	9.56	40.2	10.09	1696×1002×25/30/35/40	21.5/22/22.5/23	Si Mono	158.75*79.375	20	1500	Class A
ZXM6-HLD132-350/M	350	37.0	9.46	44.4	10.00	1860×1002×25/30/35/40	24/24.5/25/25.5	Si Mono	158.75*79.375	20	1500	Class A
ZXM6-HLD132-370/M	370	37.8	9.79	45.2	10.34	1860×1002×25/30/35/40	24/24.5/25/25.5	Si Mono	158.75*79.375	20	1500	Class A
ZXM6-HLD144-390/M	390	40.6	9.61	48.7	10.14	2024×1002×25/30/35/40	26/26.5/27/27.5	Si Mono	158.75*79.375	20	1500	Class A
ZXM6-HLD144-395/M	395	40.8	9.69	48.9	10.21	2024×1002×25/30/35/40	26/26.5/27/27.5	Si Mono	158.75*79.375	20	1500	Class A
ZXM6-HLD144-400/M	400	41.0	9.76	49.1	10.27	2024×1002×25/30/35/40	26/26.5/27/27.5	Si Mono	158.75*79.375	20	1500	Class A
ZXM6-HLD144-405/M	405	41.2	9.84	49.3	10.33	2024×1002×25/30/35/40	26/26.5/27/27.5	Si Mono	158.75*79.375	20	1500	Class A
ZXM6-NHLD120-330/M	330	33.8	9.77	40.5	10.34	1696×1002×25/30/35/40	21.5/22/22.5/23	Si Mono	158.75*79.375	20	1500	Class A
ZXM6-NHLD132-370/M	370	37.9	9.77	45.7	10.23	1860×1002×25/30/35/40	24/24.5/25/25.5	Si Mono	158.75*79.375	20	1500	Class A
ZXM6-NHLD144-400/M	400	41.2	9.71	48.8	10.43	2024×1002×25/30/35/40	26/26.5/27/27.5	Si Mono	158.75*79.375	20	1500	Class A
ZXM6-NHLD144-405/M	405	41.4	9.79	49.0	10.51	2024×1002×25/30/35/40	26/26.5/27/27.5	Si Mono	158.75*79.375	20	1500	Class A
ZXM6-NHLD144-400/M	400	40.9	9.78	49.0	10.29	2024×1002×25/30/35/40	26/26.5/27/27.5	Si Mono	158.75*79.375	20	1500	Class A

Module Type	Maximum Power Pmax <W>	Operating voltage Vmp <V>	Operating current Imp <A>	Open Circuit Voltage Voc <V>	Short Circuit Current Isc <A>	Overall Dimension <mm>	Weight <kg>	Module Series	Cell Size <mm>	Max. Series Fuse Rating <A>	MAX System voltage <V>	Application class
ZXM6-NHLD120-370/M	370	34.3	10.79	41.0	11.39	1755×1038×25/30/35/40	22/22.5/23/23.5	Si Mono	166*83	20	1500	Class A
ZXM6-NHLD144-430/M	430	40.6	10.60	49.1	11.10	2094×1038×25/30/35/40	27.5/28/28.5/29	Si Mono	166*83	20	1500	Class A
ZXM6-NHLD144-435/M	435	40.8	10.67	49.3	11.17	2094×1038×25/30/35/40	27.5/28/28.5/29	Si Mono	166*83	20	1500	Class A
ZXM6-NHLD144-440/M	440	41.0	10.74	49.5	11.25	2094×1038×25/30/35/40	27.5/28/28.5/29	Si Mono	166*83	20	1500	Class A
ZXM6-NHLD144-445/M	445	41.2	10.81	49.7	11.32	2094×1038×25/30/35/40	27.5/28/28.5/29	Si Mono	166*83	20	1500	Class A
ZXM6-NHLDD144-430/M	430	41.3	10.42	49.7	11.30	2094×1038×25/30/35/40	27.5/28/28.5/29	Si Mono	166*83	20	1500	Class A
ZXM6-NHLDD144-440/M	440	41.7	10.56	50.1	11.44	2094×1038×25/30/35/40	27.5/28/28.5/29	Si Mono	166*83	20	1500	Class A
ZXM6-NHLDD144-445/M	445	41.9	10.63	50.3	11.51	2094×1038×25/30/35/40	27.5/28/28.5/29	Si Mono	166*83	20	1500	Class A
ZXM7-SPLD120-440/M	440	34.1	12.91	41.0	13.64	1890×1133×25/30/35/40	27.5/28/28.5/29	Si Mono	182*91	25	1500	Class A
ZXM7-SPLD120-445/M	445	34.3	12.98	41.2	13.71	1890×1133×25/30/35/40	27.5/28/28.5/29	Si Mono	182*91	25	1500	Class A
ZXM7-SPLD144-530/M	530	41.0	12.94	49.3	13.66	2256×1133×25/30/35/40	32.5/33/33.5/34	Si Mono	182*91	25	1500	Class A
ZXM7-SPLD144-535/M	535	41.2	13.00	49.5	13.72	2256×1133×25/30/35/40	32.5/33/33.5/34	Si Mono	182*91	25	1500	Class A
ZXM7-SPLD144-540/M	540	41.4	13.05	49.7	13.78	2256×1133×25/30/35/40	32.5/33/33.5/34	Si Mono	182*91	25	1500	Class A
ZXM7-SPLDD120-440/M	440	34.2	12.87	41.1	13.62	1890×1133×25/30/35/40	27.5/28/28.5/29	Si Mono	182*91	25	1500	Class A
ZXM7-SPLDD120-445/M	445	34.4	12.94	41.3	13.69	1890×1133×25/30/35/40	27.5/28/28.5/29	Si Mono	182*91	25	1500	Class A
ZXM7-SPLDD144-530/M	530	41.1	12.91	49.4	13.65	2256×1133×25/30/35/40	32.5/33/33.5/34	Si Mono	182*91	25	1500	Class A
ZXM7-SPLDD144-535/M	535	41.3	12.96	49.6	13.71	2256×1133×25/30/35/40	32.5/33/33.5/34	Si Mono	182*91	25	1500	Class A
ZXM7-SPLDD144-540/M	540	41.5	13.02	49.8	13.77	2256×1133×25/30/35/40	32.5/33/33.5/34	Si Mono	182*91	25	1500	Class A

Module Type	Maximum Power Pmax <W>	Operating voltage Vmp <V>	Operating current Imp <A>	Open Circuit Voltage Voc <V>	Short Circuit Current Isc <A>	Overall Dimension <mm>	Weight <kg>	Module Series	Cell Size <mm>	Max. Series Fuse Rating <A>	MAX System voltage <V>	Application class
ZXP6-LD60-265/P	265	30.8	8.61	38.4	8.98	1658×992×25/30/35/40	21/21.5/22/22.5	Si Poly	156.75*156.75	15	1500	Class A
ZXP6-LD60-270/P	270	31.0	8.71	38.6	9.07	1658×992×25/30/35/40	21/21.5/22/22.5	Si Poly	156.75*156.75	15	1500	Class A
ZXP6-LD60-275/P	275	31.2	8.82	38.8	9.16	1658×992×25/30/35/40	21/21.5/22/22.5	Si Poly	156.75*156.75	15	1500	Class A
ZXP6-LD60-280/P	280	31.4	8.92	39.0	9.25	1658×992×25/30/35/40	21/21.5/22/22.5	Si Poly	156.75*156.75	15	1500	Class A
ZXP6-LD72-320/P	320	37.0	8.65	46.3	9.05	1978×992×25/30/35/40	25/25.5/26/26.5	Si Poly	156.75*156.75	15	1500	Class A
ZXP6-LD72-325/P	325	37.2	8.74	46.5	9.12	1978×992×25/30/35/40	25/25.5/26/26.5	Si Poly	156.75*156.75	15	1500	Class A
ZXP6-LD72-330/P	330	37.4	8.83	46.7	9.16	1978×992×25/30/35/40	25/25.5/26/26.5	Si Poly	156.75*156.75	15	1500	Class A
ZXP6-LD72-335/P	335	37.6	8.91	46.9	9.21	1978×992×25/30/35/40	25/25.5/26/26.5	Si Poly	156.75*156.75	15	1500	Class A
ZXP6-LD72-340/P	340	37.8	9.00	47.1	9.27	1978×992×25/30/35/40	25/25.5/26/26.5	Si Poly	156.75*156.75	15	1500	Class A
ZXP6-LD72-345/P	345	38.0	9.08	47.3	9.34	1978×992×25/30/35/40	25/25.5/26/26.5	Si Poly	156.75*156.75	15	1500	Class A
ZXP6-LD72-350/P	350	38.2	9.17	47.5	9.42	1978×992×25/30/35/40	25/25.5/26/26.5	Si Poly	156.75*156.75	15	1500	Class A
ZXP6-LD72-355/P	355	38.4	9.25	47.7	9.50	1978×992×25/30/35/40	25/25.5/26/26.5	Si Poly	156.75*156.75	15	1500	Class A
ZXP6-HLD120-300/P	300	32.5	9.24	39.5	9.58	1675×992×25/30/35/40	21/21.5/22/22.5	Si Poly	156.75*156.75	15	1500	Class A
ZXP6-HLD132-315/P	315	35.1	8.98	42.8	9.35	1844×992×25/30/35/40	23.5/24/24.5/25	Si Poly	156.75*156.75	15	1500	Class A
ZXP6-HLD132-330/P	330	35.7	9.25	43.4	9.61	1844×992×25/30/35/40	23.5/24/24.5/25	Si Poly	156.75*156.75	15	1500	Class A

Module Type	Maximum Power Pmax <W>	Operating voltage Vmp <V>	Operating current Imp <A>	Open Circuit Voltage Voc <V>	Short Circuit Current Isc <A>	Overall Dimension <mm>	Weight <kg>	Module Series	Cell Size <mm>	Max. Series Fuse Rating <A>	MAX System voltage <V>	Application class
ZXM7-SHLD120-440/M	440	34.1	12.91	41.0	13.64	1915×1133×25/30/35/40	27.5/28/28.5/29	Si Mono	182*91	25	1500	Class A
ZXM7-SHLD120-450/M	450	34.5	13.05	41.4	13.78	1915×1133×25/30/35/40	27.5/28/28.5/29	Si Mono	182*91	25	1500	Class A
ZXM7-SHLD144-535/M	535	41.2	13.00	49.5	13.72	2286×1133×25/30/35/40	33/33.5/34/34.5	Si Mono	182*91	25	1500	Class A
ZXM7-SHLD144-540/M	540	41.4	13.05	49.7	13.78	2286×1133×25/30/35/40	33/33.5/34/34.5	Si Mono	182*91	25	1500	Class A
ZXM7-SHLDD144-535/M	535	41.3	12.96	49.6	13.71	2286×1133×25/30/35/40	33/33.5/34/34.5	Si Mono	182*91	25	1500	Class A
ZXM7-SHLDD144-540/M	540	41.5	13.02	49.8	13.77	2286×1133×25/30/35/40	33/33.5/34/34.5	Si Mono	182*91	25	1500	Class A

9、Modify record

Revision	Date	Version No	Revisioner	Remarks (modifications, chapters, etc.)
New	2020.10.13	A	王三槐	Full text of Installation Manual