



User Manual

SAJ Solar Inverter Suntrio Plus Series



www.saj-electric.com

Preface

Thank you for choosing a SAJ solar inverter. We are pleased to provide you with first-class products and exceptional service.

This manual includes information for installation, operation, maintenance, trouble shooting and safety. Please follow the instructions of this manual so that we can ensure delivery of our professional guidance and wholehearted service.

Customer-orientation is forever our commitment. We hope this document proves to be of great assistance in your journey for a cleaner and greener world.

Please check for the latest version at www.saj-electric.com

Guangzhou Sanjing Electric Co., Ltd.

Building e-Energy Management Solution Provider

Content

Preface.....	- 1 -
Content.....	- 2 -
Chapter 1 Safety Precautions	- 4 -
1.1 Scope of Application	- 4 -
1.2 Safety Instructions	- 4 -
1.3 Target Group.....	- 5 -
Chapter 2 Preparation	- 6 -
2.1 Safety Instructions	- 6 -
2.2 Explanations of Symbols.....	- 8 -
Chapter 3 Product Information	- 9 -
3.1 Application Scope of Products	- 9 -
3.2 Specification for Product Model.....	- 10 -
3.3 Overview of products	- 10 -
3.4 Datasheet	- 12 -
Chapter 4 Instructions for installation	- 16 -
4.1 Safety Instructions	- 16 -
4.2 Pre-installation Check.....	- 16 -
4.3 The Determination of the Installation Method and Position.....	- 17 -
4.4 Mounting Procedure	- 19 -
Chapter 5 Electrical Connection	- 24 -
5.1 Safety Instruction for Hot-line Job	- 24 -
5.2 Specifications for Electrical Interface.....	- 25 -
5.3 AC Side Connection.....	- 27 -
5.4 DC Side Connection	- 30 -
5.5 Communication Connection.....	- 32 -

Chapter 6	Debugging Instructions	- 34 -
6.1	Introduction of Human-Computer Interface	- 34 -
6.2	First Run Setup.....	- 35 -
6.3	Monitoring Operation	- 49 -
Chapter 7	Fault Code and Troubleshooting.....	- 50 -
Chapter 8	Recycling and Disposal	- 53 -
Chapter 9	Guarantee Service	- 54 -
Chapter 10	Contact SAJ	- 55 -
SAJ	Warranty Policy	- 56 -
Warranty Card	- 61 -

Chapter 1 Safety Precautions

1.1 Scope of Application

This User Manual describes instructions and detailed procedures for installing, operating, maintaining, and troubleshooting of the following SAJ grid-tied inverters:

Suntrio Plus 12K; Suntrio Plus 15K; Suntrio Plus 17K; Suntrio Plus 20K; Suntrio Plus 25K; Suntrio Plus 30K; Suntrio Plus 33K; Suntrio Plus 40K; Suntrio Plus 50K; Suntrio Plus 60K

Please keep this manual all time available in case of emergency.

1.2 Safety Instructions



DANGER

· DANGER indicates a hazardous situation, which, if not avoided, will result in death or serious injury.



WARNING

· WARNING indicates a hazardous situation, which, if not avoided, can result in death or serious injury or moderate injury.



CAUTION

· CAUTION indicates a hazardous condition, which, if not avoided, can result in minor or moderate injury.



NOTICE

· NOTICE indicates a situation that can result in potential damage, if not avoided.

1.3 Target Group

Only qualified electricians who have read and fully understood all safety regulations contained in this manual can install, maintain and repair the inverter. Operators must be aware of the high-voltage device.

Chapter 2 Preparation

2.1 Safety Instructions



DANGER

- Dangerous due to electrical shock and high voltage.
- Do not touch the operating component of the inverter, or it might result in burning or death.
- To prevent risk of electric shock during installation and maintenance, please make sure that all AC and DC terminals are plugged out.
- Do not touch the surface of the inverter while the housing is wet, or it might lead to electrical shock.
- Do not stay close to the inverter while there are severe weather conditions including storm, lightning, etc.
- Before opening the housing, the SAJ inverter must be disconnected from the grid and PV generator; you must wait for at least five minutes to let the energy storage capacitors fully be discharged after disconnecting from power source.



WARNING

- The installation, service, recycling and disposal of the inverters must be performed by qualified personnel only in compliance with national and local standards and regulations.
- Any unauthorized actions including modification of product functionality of any form may cause lethal hazard to the operator, third parties, the units or their property. SAJ is not responsible for the loss and these warranty claims.
- The SAJ inverter must only be operated with PV generator. Do not connect any other source of energy to the SAJ inverter.
- Be sure that the PV generator and inverter are well grounded in order to protect safety of people's life and property.



CAUTION











- The PV inverter will become hot during operation. Please do not touch the heat sink or peripheral surface during or shortly after operation.

·Risk of damage due to improper modifications.

 **NOTICE**

- Public utility only
- The PV inverter is designed to feed AC power directly to the public utility power grid; do not connect AC output of the inverter to any private AC equipment.

2.2 Explanations of Symbols

Symbol	Description
	Dangerous electrical voltage This device is directly connected to public grid, thus all work to the inverter shall only be carried out by qualified personnel.
	DANGER to life due to high electrical voltage! There might be residual currents in inverter because of large capacitors. Wait for 5 MINUTES before you remove the front lid.
	NOTICE, danger! This is directly connected with electricity generators and public grid.
	Danger of hot surface The components inside the inverter will release a lot of heat during operation. Do not touch metal plate housing during operating.
	An error has occurred Please refer to Chapter 9 "Troubleshooting" to remedy the error.
	This device SHALL NOT be disposed of as residential waste Please go to Chapter 8 "Recycling and Disposal" for proper treatments.
	Without Transformer This inverter does not use transformer for the isolation function.
	CE Mark Equipment with the CE mark fulfills the basic requirements of the Guideline Governing Low-Voltage and Electro-magnetic Compatibility.
	CQC Mark The inverter complies with the safety instructions from China's Quality Center.
 ATTENTION Risk of electric shock! Only authorized operations are allowed to do disassembly, modification or maintenance. Any resulting defect or damage (device/person) is not covered by SAJ guaranty.	No unauthorized operations or modifications Any unauthorized operations or modifications are strictly forbidden, if any defect or damage (device/person) occurs, SAJ shall not take any responsibility for it.

Chapter 3 Product Information

3.1 Application Scope of Products

Suntrio Plus series products are grid-tied three phase inverters without transformers, and the inverters are important components of grid-tied solar power systems.

The Suntrio Plus inverters change the DC generated by solar panels into AC which is in accordance with the requirements of public grid, and send the AC into the grid, Table 3.1 shows the structural diagram of the typical application system of Suntrio Plus inverters.

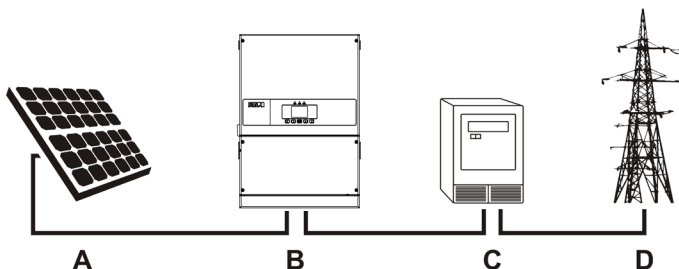

Figure 3.1 Overview of photovoltaic system

Name	Description	Remarks
A	Solar panels	Monocrystalline or polycrystalline silicon, and thin-film PV modules with II protection and need no ground connection
B	Inverters	Suntrio Plus 12K/15K/17K/20K/25K/30K/33K/40K/50K/60K
C	Metering equipment	Standard metering tool for measuring the output electric power of inverters
D	Power grid	TT, TN-C, TN-S, TN-C-S

Table 3.1 Systematic configuration diagram

3.2 Specification for Product Model

Suntrio Plus XK

①

②

① Suntrio Plus represents for product name.

② XK represents rated power XkW of inverter, for example, 12K means 12kW.

3.3 Overview of products

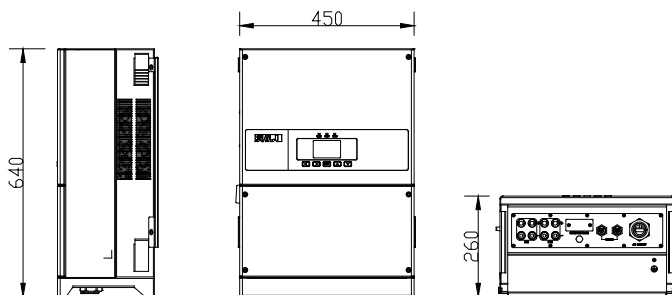

Figure 3.2 Overview of Suntrio Plus 12K/15K/17K/20K

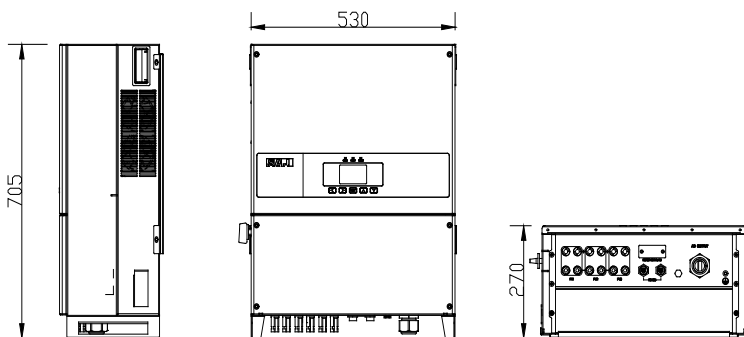

Figure 3.3 Overview of Suntrio Plus 25K/30K/33K

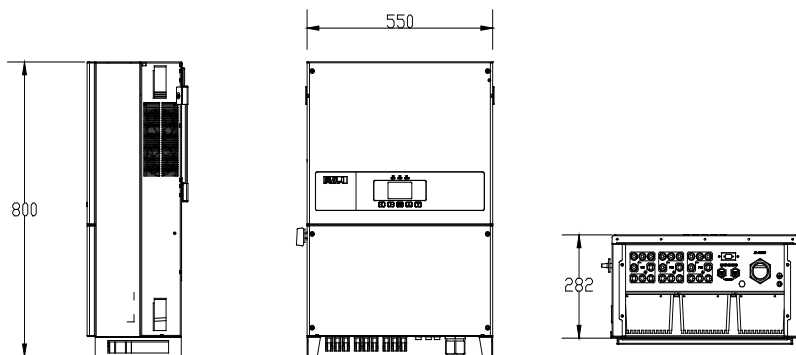

Figure 3.4 Overview of Suntrio Plus 40K/50K/60K

3.4 Datasheet

Suntrio Plus 12K/15K/17K/20K/25K

Type	Suntrio Plus 12K	Suntrio Plus 15K	Suntrio Plus 17K	Suntrio Plus 20K	Suntrio Plus 25K
Input (DC)					
Max. PV Array Power [Wp]@STC ₁	18000	22500	25500	26000	37500
Max. DC Voltage [V]	1000				
MPPT Voltage Range [V]	180-900				
Nominal DC Voltage [V]	600				
Start Voltage[V]	200				
Min. DC Voltage[V]	180				
Max. DC Input Current PV1 / PV2 [A]	22/11	22/22	22/22	22/22	22/22/22
Number of MPPT	2				3
Number of DC Connection Sets per MPPT	2/1	2/2	2/2	2/2	2/2/2
DC Switch	Integrated				
Output (AC)					
Rated AC Power [W] (@230V,50Hz)	12000	15000	17000	20000	25000 ² /25000
Max. AC Power [VA]	13200	16500	18700	22000	25000/27500
Rated AC Current[A]	17.4	21.7	25.8	29.0	37.9
Max. AC Current [A]	20.0	25.0	28.3	33.0	42.0
Nominal AC voltage/ range	3/N/PE, 220/380V,230/400V,240/415V;180V-280V/312V-485V				
Grid frequency/ range	50Hz,60Hz /44Hz-55Hz,54Hz-65Hz				
Power factor,adjustable	0.8 leading~0.8lagging				
Total Harmonic Distortion (THDi)	< 3% (at nominal power)				
Feed-in Grid	3L+N+PE				
Efficiency					
Max. Efficiency	98.3%	98.4%	98.5%	98.5%	98.6%
Euro Efficiency (at 600Vdc)	98.0%	98.1%	98.2%	98.2%	98.4%
MPPT Accuracy	>99.5%				
Protection					
Internal Over-voltage Protection	Integrated				
DC Insulation Monitoring	Integrated				
DCI Monitoring	Integrated				
GFCI Monitoring	Integrated				

Grid Monitoring	Integrated		
AC Short Circuit Current Protection	Integrated		
Thermal Protection	Integrated		
AC Surge Protection	III(Integrated), II (Optional)		II (Integrated)
Low Voltage Ride Through	Integrated		
String Current Monitoring	Integrated		
Anti-PID Module	Optional		
DC Fuse	Optional		
DC Surge Protection	II (Optional)		II (Integrated)
Anti-island protection monitoring	AFD		
Interface			
DC Connection	MC4/H4		
AC Connection	Terminal Block		
LCD Display	3.5 inch Graphic LCD Display		
Display Language	English		
Communication Port	2*RS485+1*RS232		
Communication Mode	Wi-Fi/GPRS/Ethernet (Optional)		
General Data			
Topology	Transformerless		
Consumption at Night [W]	<0.6		
Consumption at Standby [W]	<10		
Operating Temperature Range	-25°C to +60°C(45°C to 60°C with derating)		
Cooling Method	Intelligent Fan		
Ambient Humidity	0 to 100% Non-condensing		
Altitude	3000m (>2000m power derating)		
Noise [dBA]	<35		
Ingress Protection	IP65 (Indoor & Outdoor Installation)		
Mounting	Rear Panel		
Dimensions (H*W*D) [mm]	640*450*250		705*530*260
Net Weight [kg]	29	33	48
Standard Warranty [Year]	5 (standard)/10/15/20/25 (Optional)		
Certificates	IEC/EN62109-1/2, EN61000-6-2/3, IEC61683, IEC60068-2, IEC62116, IEC61727, VDE0126-1-1/A1, VDE-AR-N 4105, CQC NB/T 32004, G99,NBR 16149, NBR16150,C10/11,EN50438,G59/3		

Suntrio Plus 30K/33K/40K/50K/60K

Type	Suntrio Plus 30K	Suntrio Plus 33K	Suntrio Plus 40K	Suntrio Plus 50K	Suntrio Plus 60K
Input (DC)					
Max. PV Array Power [Wp]@STC ₁	40000	40000	60000	65000	78000
Max. DC Voltage [V]	1000				
MPPT Voltage Range [V]	180-900		280-900		
Nominal DC Voltage [V]	600				
Start Voltage[V]	200		300		
Min. DC Voltage[V]	180		250		
Max. DC Input Current PV1 / PV2 [A]	22/22/22		44/33/33		44/44/44
Number of MPPT	3				
Number of DC Connection Sets per MPPT	2/2/2		4/3/3		4/4/4
DC Switch	Integrated				
Output (AC)					
Rated AC Power [W] (@230V,50Hz)	30000	30000	40000	50000	60000
Max. AC Power [VA]	30000	33000	44000	55000	60000
Rated AC Current[A]	43.5	45.5	58.0	72.5	87.0
Max. AC Current [A]	50.0	50.0	65.0	80.0	90.0
Nominal AC voltage/ range	3/N/PE, 220/380V,230/400V,240/415V;180V-280V/312V-485V				
Grid frequency/ range	50Hz,60Hz /44Hz-55Hz,54Hz-65Hz				
Power factor,adjustable	0.8 leading~0.8lagging				
Total Harmonic Distortion (THDi)	< 3% (at nominal power)				
Feed-in Grid	3L+N+PE				
Efficiency					
Max. Efficiency	98.8%	98.8%	98.8%	98.8%	98.9%
Euro Efficiency (at 600Vdc)	98.5%	98.5%	98.5%	98.5%	98.6%
MPPT Accuracy	>99.5%				
Protection					
Internal Over-voltage Protection	Integrated				
DC Insulation Monitoring	Integrated				
DCI Monitoring	Integrated				
GFCI Monitoring	Integrated				
Grid Monitoring	Integrated				
AC Short Circuit Current Protection	Integrated				
Thermal Protection	Integrated				
AC Surge Protection	II (Integrated)				

Low Voltage Ride Through	Integrated	
String Current Monitoring	Integrated	
Anti-PID Module	Optional	
DC Fuse	Optional	
DC Surge Protection	II (Integrated)	
Anti-island protection monitoring	AFD	
Interface		
DC Connection	MC4/H4	
AC Connection	Terminal Block	
LCD Display	3.5 inch Graphic LCD Display	
Display Language	English	
Communication Port	2*RS485+1*RS232	
Communication Mode	Wi-Fi/GPRS/Ethernet (Optional)	
General Data		
Topology	Transformerless	
Consumption at Night [W]	<0.6	
Consumption at Standby [W]	<10	
Operating Temperature Range	-25°C to +60°C(45°C to 60°C with derating)	
Cooling Method	Intelligent Fan	
Ambient Humidity	0 to 100% Non-condensing	
Altitude	3000m (>2000m power derating)	
Noise [dBA]	<35	
Ingress Protection	IP65 (Indoor & Outdoor Installation)	
Mounting	Rear Panel	
Dimensions (H*W*D) [mm]	705*530*260	800*550*280
Net Weight [kg]	48	68
Standard Warranty [Year]	5 (standard)/10/15/20/25 (Optional)	
Certificates	IEC/EN62109-1/2, EN61000-6-2/3, IEC61683, IEC60068-2, IEC62116, IEC61727, VDE0126-1-1/A1, VDE-AR-N 4105, CQC NB/T 32004, G99,NBR 16149, NBR 16150,C10/11,EN50438, RD1669,UNE206006,UNE206007,G59/3	

Note:

- 1.1000W/m² 25°C
- 2.Applicable to Belgian grid standard.
- 3.The above parameters might be slightly modified according to different grid codes.
- 4.If you need more information about our product certifications, please contact our sales.

Chapter 4 Instructions for installation

4.1 Safety Instructions



DANGER

- Dangerous to life due to potential fire or electricity shock.
- Do not install the inverter near any inflammable or explosive items.
- This inverter will be directly connected with HIGH VOLTAGE power generation device; the installation must be performed by qualified personnel only in compliance with national and local standards and regulations.



NOTICE

- This equipment is suitable for the pollution degree II.
- Inappropriate or unharmonized installation environment may jeopardize the life span of the inverter.
- Installation directly exposed under intensive sunlight is not recommended.
- The installation site must have good ventilation condition.

4.2 Pre-installation Check

4.2.1 Check the Package

Although SAJ's inverters have surpassed stringent testing and are checked before leaving factory, it is still possible that the inverters may suffer damages during transportation. Please check the package for any obvious signs of damage, and if such evidence is present, do not open the package and contact your dealer as soon as possible.

4.2.2 Check the Assembly Parts

Please refer to the Packing List inside the package container.

4.3 The Determination of the Installation Method and Position

4.3.1 Mounting Method

Please mount the inverter correctly as shown in Figure4.1 below.

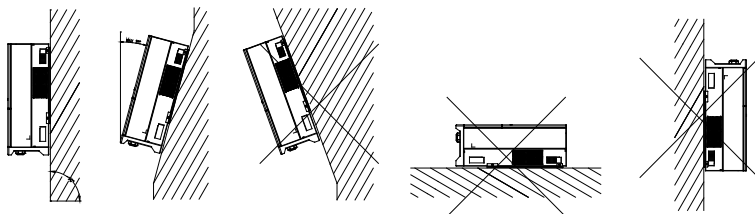

Figure 4.1 Mounting Method

- ① The equipment employs natural convection cooling, and it can be installed indoor or outdoor.
- ② Please install the equipment under the guidance of Figure4.1. Vertical installation on floor level is recommended. Mount vertically or tilted backwards by max. 15°. Never install the inverter tilted forward, sideways, horizontally or upside down.
- ③ Considering convenience for maintenance, please install the equipment at a position in parallel with line of sight.
- ④ When mounting the inverter, please consider the solidity of wall for inverter, including accessories. Please ensure the Rear Panel mount tightly.

Before installation, make sure that the wall has enough strength to hold the screws and bear the weight of the equipment. Please make sure the equipment is installed properly.

4.3.2 Installation Position

Do not expose the inverter to direct solar irradiation as this could cause power derating due to overheating. The ambient temperature should be between -25°C ~ +60°C (-13° F ~ 140° F) to ensure optimum operation. Choose locations with sufficient air exchange. Ensure additional ventilation,

if necessary.

To make sure the installation spot is suitably ventilated, if multiple SAJ on-grid solar inverters are installed together, the following safety clearance in Figure 4.2 shall be followed for proper ventilation conditions.

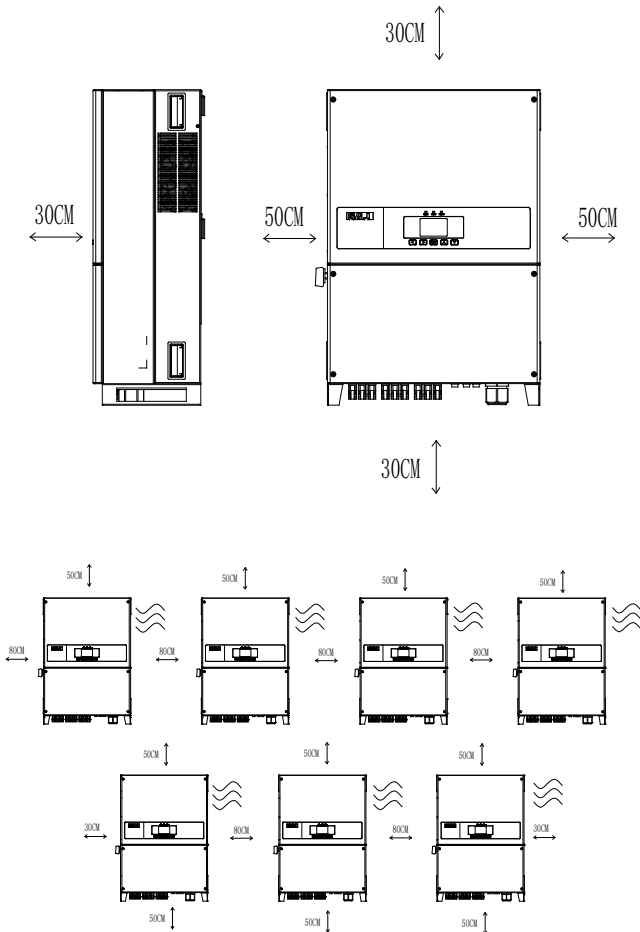

Figure 4.2 Minimum clearance

4.4 Mounting Procedure

4.4.1 Mark the Positions of the Drill Holes of the Rear Panel

The mounting positions should be marked as shown in Figure 4.3, Figure 4.4 and Figure 4.5.

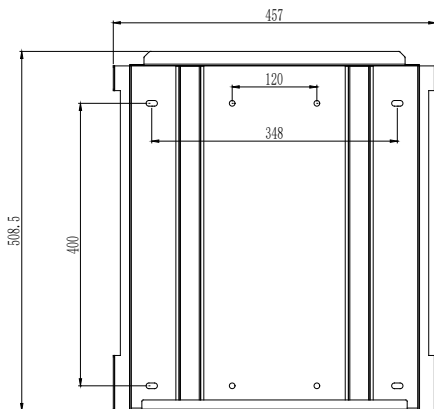

Figure 4.3 Dimensions of rear panel Suntrio Plus 12K/15K/17K/20K

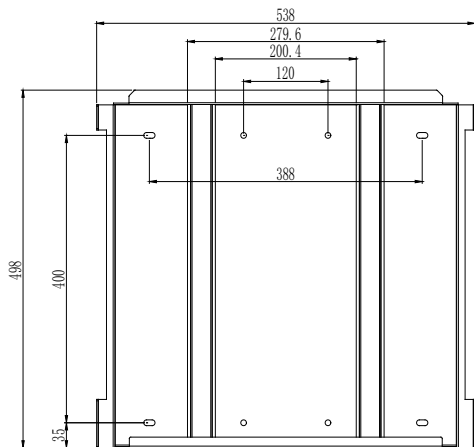

Figure 4.4 Dimensions of rear panel Suntrio Plus 25K/30K/33K

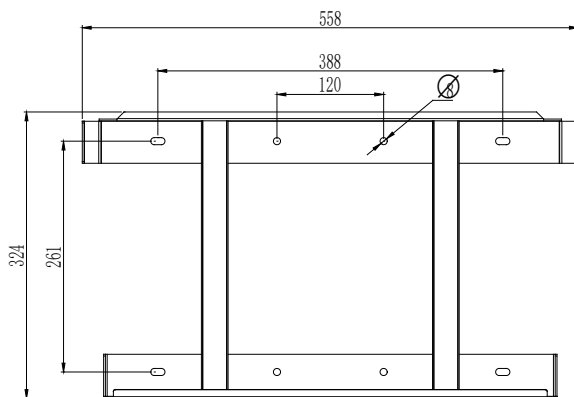

Figure 4.5 Dimensions of rear panel Suntrio Plus 40K/50K/60K

4.4.2 Drill Holes and Place the Expansion Tubes

Follow the given guides, drill 3 holes in the wall (in conformity with position marked in Figure 4.6, Figure 4.7 and Figure 4.8), and then place expansion tubes in the holes using a rubber mallet.

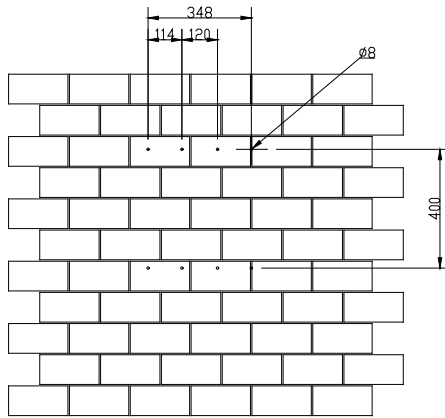

Figure 4.6 Drill holes (Suntrio Plus 12K/15K/17K/20K)

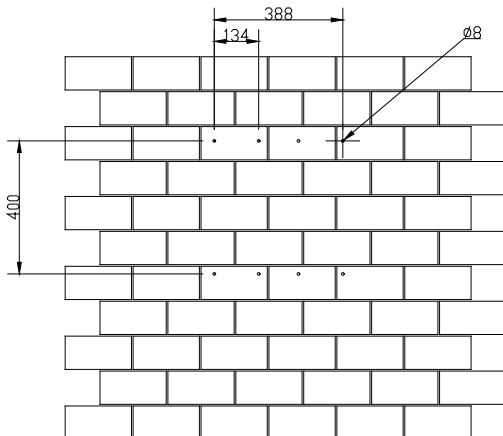

Figure 4.7 Drill holes (Suntrio Plus 25K/30K/33K)

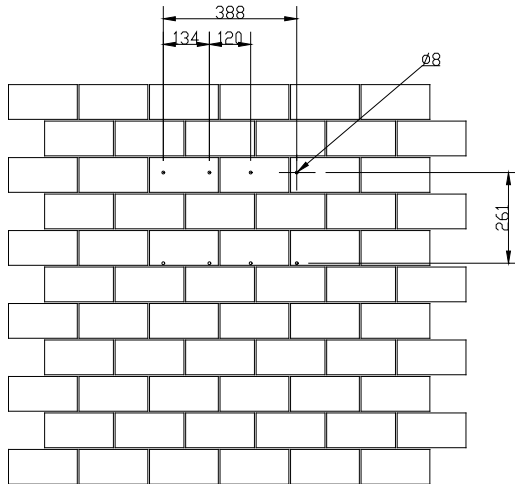

Figure 4.8 Drill holes (Suntrio Plus 40K/50K/60K)

4.4.3 Mount the Screws and the Rear Panel

The panels should be mounted in the mounting position by screws as shown in Figure 4.9.

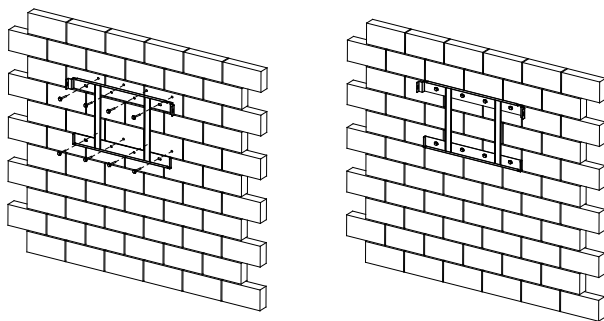

Figure 4.9 Mount the rear panel

4.4.4 Mount the Inverter

Carefully mount the inverter to the rear panel. Make sure that the rear part of the equipment is closely mounted to the rear panel.

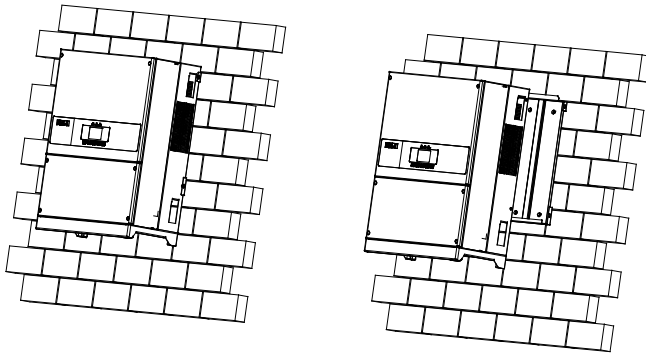

Figure 4.10 Mount the inverter

Chapter 5 Electrical Connection

5.1 Safety Instruction for Hot-line Job

Electrical connection must only be operated by professional technicians. Please keep in mind that the inverter is a bi-power supply equipment. Before connection, necessary protective equipment must be employed by technicians, including insulating gloves, insulating shoes and safety helmet.

 **DANGER**

- Dangerous to life due to potential fire or electricity shock.
- When power-on, the equipment should be in conformity with national rules and regulations.
- The direct connection between the converter and high voltage power systems must be operated by qualified technicians in accordance with local and national power grid standards and regulations.

⚠ WARNING

·When the photovoltaic array is exposed to light, it supplies a d.c voltage to the inverter.

⚠ NOTICE

·Electrical connection should be in conformity with proper stipulations, such as stipulations for cross-sectional area of conductors, fuse and ground protection.
·The overvoltage category on DC input port is II, and that on AC output port is III.

5.2 Specifications for Electrical Interface

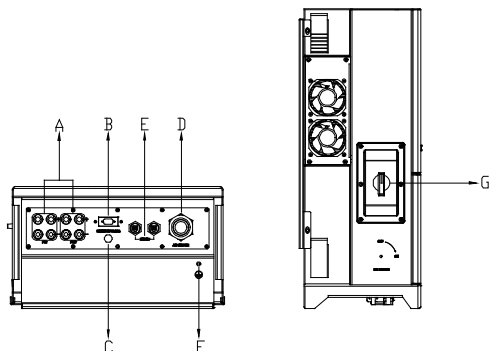

Figure 5.1 Suntrio Plus-12/ 15/ 17/ 20K electrical interface

Code	Name
A	DC Input
B	RS232/Wi-Fi Port
C	Decompression valves
D	AC output
E	RS485 port
F	Ground Connecting port

G	DC Switch
---	-----------

Table 5.1 Specifications for Suntrio Plus-12/ 15/ 17/ 20K interface

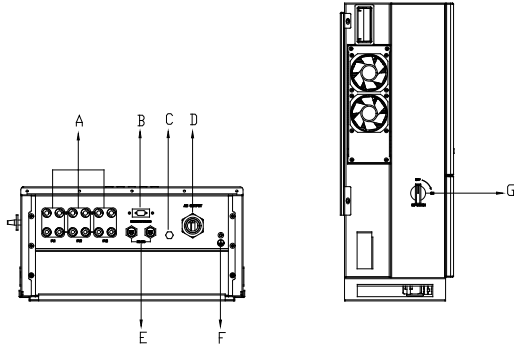

Figure 5.2 Suntrio Plus-25/ 33K electrical interface

Code	Name
A	DC Input
B	RS232/Wi-Fi Port
C	Decompression valves
D	AC output
E	RJ45 Port
F	Ground Connecting port
G	DC Switch

Table 5.2 Specifications for Suntrio Plus-25/ 33K interface

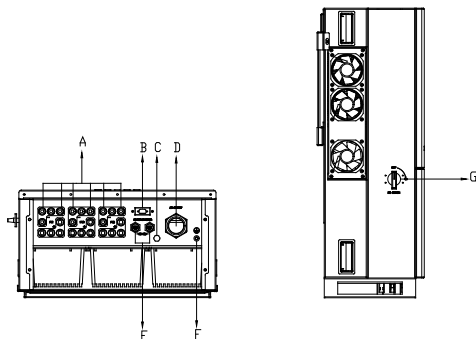

Figure 5.3 Suntrio Plus-40/ 50/ 60K electrical interface

Code	Name
A	DC Input
B	RS232/Wi-Fi Port
C	Decompression valves
D	AC output
E	RJ45 Port
F	Ground Connecting port
G	DC Switch

Table 5.3 Specifications for Suntrio Plus-40/ 50/ 60K interface

5.3 AC Side Connection

Type	Recommended copper cable	
	Cross sectional area (mm ²)	External diameter (mm)
Suntrio Plus 12K	4×6+1×4	15.6
Suntrio Plus 15K/17K/20K	4×10+1×6	18.1
Suntrio Plus 25K/30K/33K	4×16+1×10	20.8
Suntrio Plus 40K/50K/60K	4×35+1×16	27.1

Table 5.4 Recommended specifications of AC cables

5.3.1 Open the lid of installation area.

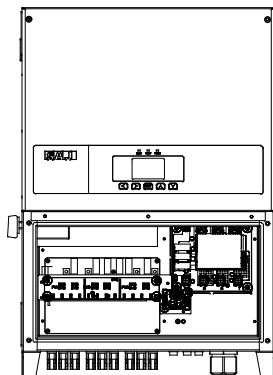

Figure 5.4 Open cover

There are some optional functions available, such as AC surge protection (Class 2), DC surge protection, Anti-PID, and DC fuses. These were integrated in the inverters before leaving the factory.

5.3.2 Feed AC cable through the AC cable hole, and connect the cable to terminals as the marks L1,L2,L3,N,PE shows.

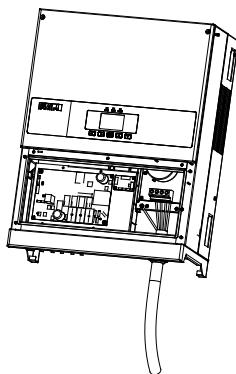

Figure 5.5 Connect the cables

5.3.3 Secure all parts of the AC waterproof connector tightly.

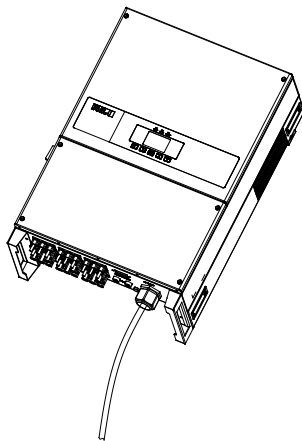

Figure 5.6 Screw the connector

5.3.4 Cover the lid and tighten the screws

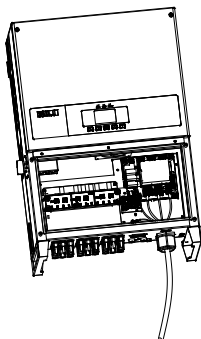

Figure 5.7 Cover the lid

5.4 DC Side Connection

Cross-sectional Area of Cables (mm ²)		Outside Diameter of the Cables (mm)
Scope	Recommended Value	
4.0-6.0	4.0	4.2~5.3

Table 5.5 Recommended specifications of DC cables

DC connector is made up of the positive connector and the negative connector

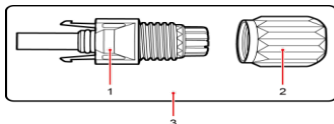

1. Insulated Enclosure 2. Lock Screw 3. Positive Connector

Figure 5.8 Positive connector

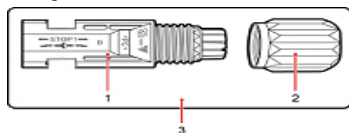

1. Insulated Enclosure 2. Lock Screw 3. Negative Connector

Figure 5.9 Negative connector

! NOTICE

·Please place the connector separately after unpacking in order to avoid confusion for connection of cables.

·Please connect the positive connector to the positive side of the solar panels, and connect the negative connector to the negative side of the solar side. Be sure to connect them in right position.

Connecting Procedures:

1. Tighten the lock screws on positive and negative connector.
2. Use specified strip tool to strip off the insulated enclosure of the positive and negative cables with appropriate length.

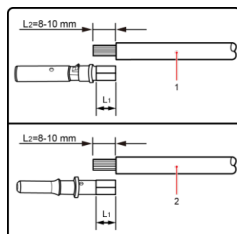

1.Positive Cable

2. Negative Cable

Figure 5.10 Connecting cables

3. Feed the positive and negative cables into corresponding lock screws.
4. Insert the positive and negative connectors into positive cable and negative cable whose insulated enclosure has been stripped off, and crimp them tightly with a wire crimper. Make sure that the withdrawal force of the pressed cable is bigger than 400N.
5. Plug in the pressed positive and negative cables into relevant insulated enclosure, a “click” sound should be heard when the contact cable assembly is seated correctly.
6. Fasten the lock screws on positive and negative connectors into respective insulated enclosure and make them tight.
7. Connect the positive and negative connectors into positive and negative DC input terminals of the inverter, a “click” sound should be heard when the contact cable assembly is seated correctly.

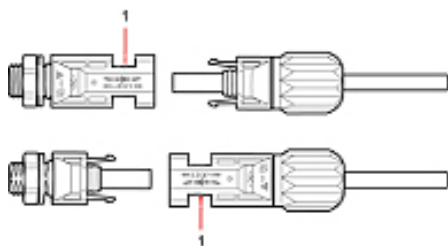

1. Connection Port

Figure 5.11 Connect the inverter



NOTICE

·Before inserting the connector into the DC input terminal of the inverter, please make sure that the DC switch of the inverter is OFF.

5.5 Communication Connection

Suntrio Plus 12K/20K/25K/30K/33K/40K/50K/60K are equipped with a RJ45 interface for communication module connection.

Each connection port should be attached to the connector as shown in Figure 5.14 and Table 5.8. Make sure the connection is tight and secure.

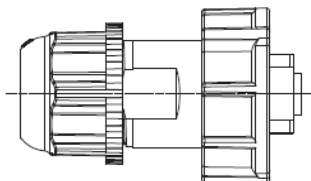

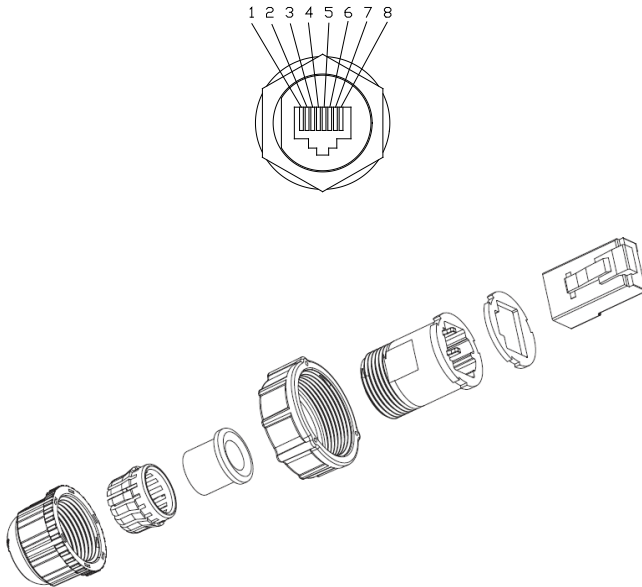

Pin	Name	Function
1	N.C	/
2	GND_W	Ground
3	N.C	/
4	N.C	/
5	N.C	/
6	N.C	/
7	RS485-A	Transmit RS485 signal
8	RS485-B	

Table 5.8 Pins specification of RJ45

Chapter 6 Debugging Instructions

6.1 Introduction of Human-Computer Interface

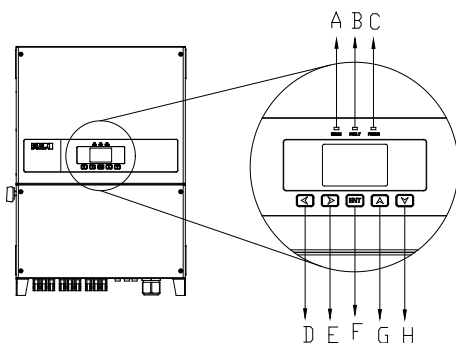

Figure 6.1 Human-Computer Interface

Object	Description		
A	Communication status	Yellow light blinking	Sending data
		Blue light blinking	Receiving data
B	Inverter status	Solid red	The inverter has detected fault
		Solid green	The inverter is on-grid and running
		Off	The inverter is in initializing state or count downing for grid-tie
C	Power status	Solid yellow	The power system of inverter is operating normally
D	Moves the cursor to the left		

E ▶	Moves the cursor to the right
F(ENT)	Enter into the menu, or confirm selection
G ▲	Moves the cursor up or increases the setting value
H ▼	Moves the cursor down or reduces the setting value

6.2 First Run Setup

6.2.1 Set the Country

When the solar inverter begins to run for the first time, please configure the time of usage, and the inverter LCD will display as below:

Graph	Setting	Run-Info	About	
Please Set Time & Date				Power 0 W
Date:	<input type="text" value="09/23/2015"/>			E-Today 0.00 kWh
Time:	<input type="text" value="13:23:56"/>			E-Total 0.00 kWh
<input type="button" value="OK"/>		<input type="button" value="Return"/>		T-Today 0.0 h
				T-Total 0.0 h
Init	Set system Time	15-06-09	15: 47	

Figure 6.2 Set the Time

Users can press Up, Down, Left, Right and ENT buttons to set local time and confirm the selection. Then the inverter will display the interface for country selection as shown in Figure 6.3:

Graph	Setting	Run-Info	About	
Country	<input type="text" value="1"/>	Please set grid country		Power 0 W
Australia				E-Today 0.00 kWh
Australia				E-Total 0.00 kWh
Belgium				T-Today 0.0 h
Brazil				T-Total 0.0 h
Denmark				
Finland				
France				
Luxembourg				
Netherlands				
Init	Grid Compliance	15-06-09	15: 47	

Figure 6.3 Set The Country

Please press the "ENT" button, LCD will show the countries for option. Users can press "▼" or "▲" to select the correct country and press "ENT"

button to confirm the selection.

Note: The configuration of the country of usage must be set before inverter starts to run for its first time; otherwise, the inverter will not operate correctly. If users cannot locate the corresponding country, please abort the setting and contact the after sales for confirmation.

6.2.2 State

If the country has been set the LCD shows the machine type when the inverter is started up, then it automatically displays the inverter operation status: Initialization, Normal, Wait, Fault or Update.

Data name	Explanation
Initialization	Initialization of the system
Normal	The inverter in normal (function) operation
Wait	The inverter in stand-by state
Fault	A fault occurs during operation
Update	The state of updating firmware

Turn on the AC switch, the LCD begins to count seconds backwards, after this, the inverter begins to connect the grid.

6.2.3 LCD Menu

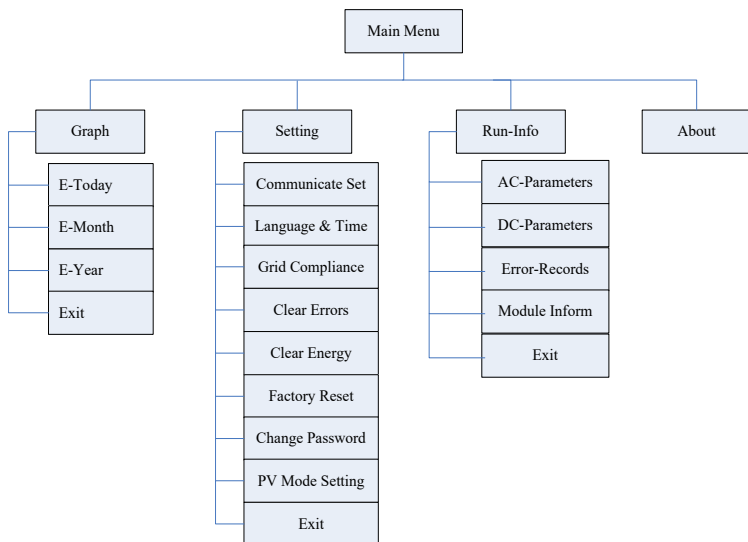
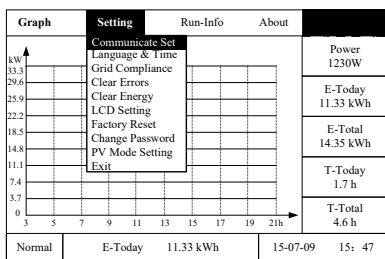

Figure 6.4 LCD Menu

6.2.4 Settings of General Parameters of the Inverter

LCD Display		Operation Steps
1. Settings of figures		
Graph Set		<p>In the main LCD interface, press “ENT” button to enter into the selection of “Graph”, press \blacktriangledown or \blacktriangle to select. The LCD displays daily, monthly, yearly and gross generating capacity.</p>
2. Settings of System Parameter		

Communicate Set



1. In the main LCD interface, press “ENT” button, then press **▶** to enter into “Setting”.

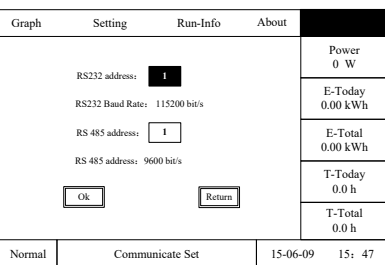

2. Press ENT to enter into “Communication Settings”. Press **▼** and **▲** to set the communication address of Wi-Fi and RS485. The Fault address is 1.

Language & Time

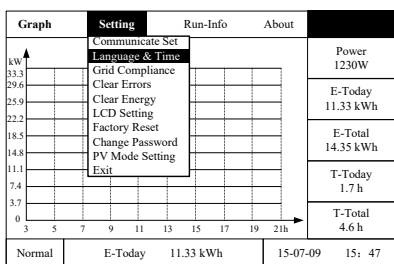

1. In the main LCD interface, press “ENT” button, then press **▶** to enter into “Setting”.

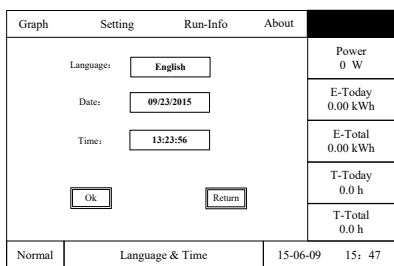

2. Press **▼** and then press ENT to enter into “Language & Time”. Press **▲** and **▼** to set the language, date and time.

Grid Compliance

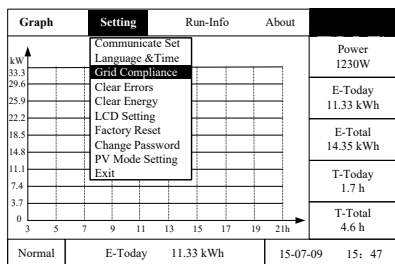

1. In the main LCD interface, press “ENT” button, then press \blacktriangleright to enter into “Setting”.

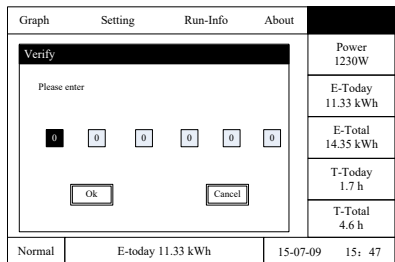

2. Press \blacktriangledown and then press ENT to enter password and enter into country setting. Attention: Please contact SAJ if you need password.

Grid Compliance

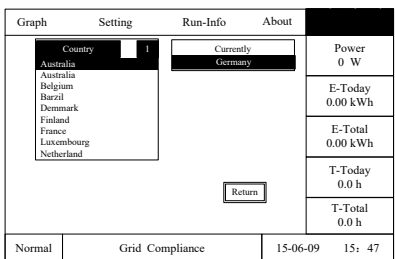

3. Press \blacktriangle and \blacktriangledown to select country, Then click OK to save the changes.

Clear Errors

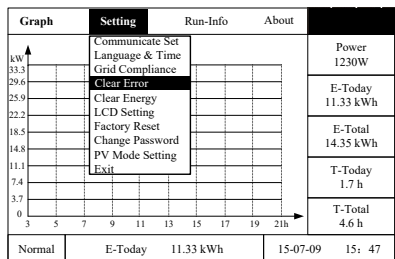

1. In the main LCD interface, press “ENT” button, then press \blacktriangleright to enter into “Setting”.

		<p>2. Press ▼ and then press ENT to enter into “Clear Fault Records”, click OK or return back.</p>
		<p>1. In the main LCD interface, press “ENT” button, then press ▶ to enter into “Setting”.</p>
<p>Clear Energy</p>		<p>2. Press ▼ and then press ENT to enter into “Clear Energy”, click OK or return back.</p>
<p>LCD Setting</p>		<p>1. In the main LCD interface, press “ENT” button, then press ▶ to enter into “Setting”.</p>

		<p>2. Press ▼ and then press ENT to enter into “Display Settings”, and then press ▲ and ▼ to change the sleep time of LCD, click OK or return back.</p>
Factory Reset		<p>1. In the main LCD interface, press “ENT” button, then press ► to enter into “Setting”.</p>
Factory Reset		<p>2. Press ▼ and then press ENT to enter password, and then enter into Factory Settings. Attention: Please contact SAJ if you need password.</p>
Factory Reset		<p>3. Click OK to save the changes.</p>

Change Password	<p>Graph Setting Run-Info About</p> <p>Power 1230W E-Today 11.33 kWh E-Total 14.35 kWh T-Today 1.7 h T-Total 4.6 h</p> <p>Normal E-Today 11.33 kWh 15-07-09 15: 47</p>	1. In the main LCD interface, press “ENT” button, then press ▶ to enter into “Setting”.
	<p>Graph Setting Run-Info About</p> <p>Power 1230W E-Today 11.33 kWh E-Total 14.35 kWh T-Today 1.7 h T-Total 4.6 h</p> <p>Normal E-today 11.33 kWh 15-07-09 15: 47</p>	2. Press ▼ and then press ENT to enter password, and then enter into Reset Password. Attention: Please contact SAJ if you need password.
Change Password	<p>Graph Setting Run-Info About</p> <p>Power 1230W E-Today 11.33 kWh E-Total 14.35 kWh T-Today 1.7 h T-Total 4.6 h</p> <p>Normal Chang Password 15-07-09 15: 47</p>	3. Enter the new password and click OK to save the change.
	PV Mode Setting	<p>Graph Setting Run-Info About</p> <p>Power 1230W E-Today 11.33 kWh E-Total 14.35 kWh T-Today 1.7 h T-Total 4.6 h</p> <p>Normal E-Today 11.33 kWh 15-07-09 15: 47</p>

Graph	Setting	Run-Info	About
PV Mode Setting PV Independent <input type="button" value="Ok"/> <input type="button" value="Cancel"/>			Power 1230W E-Today 11.33 kWh E-Total 14.35 kWh T-Today 1.7 h T-Total 4.6 h
Normal	Chang Password	15-07-09	15: 47

2. Press ▼ and then press ENT to enter into "PV Mode Setting". Press ▲ and ▼ to choose PV mode. then choose to confirm.

- 1-- PV1, PV3, PV2 independent
- 2-- PV1//PV2; PV3 independent
- 3-- PV1//PV3; PV2 independent
- 4-- PV2//PV3; PV1 independent
- 5-- PV1//PV2// PV3

Attention: This mode shall be set before the inverter is connected to the power grid, and don't set it when the inverter is being connected to the grid.

6.2.5 Inquiry of Parameters of Inverter

Graph	Setting	Run-Info	About
		AC-Parameters DC-Parameters Error-Records Module-Inform Exit	Power 1230W E-Today 11.33 kWh E-Total 14.35 kWh T-Today 1.7 h T-Total 4.6 h
Normal	E-Today 11.33 kWh	15-07-09	15: 47

1. Inquiry of Operating Parameters

1. In the main LCD interface, press "ENT" button, then press ▶ to enter into "Parameters".
2. Press ENT to enter into "Run-Info", then press ▼ or ▲ to select the needed parameters, press ENT to enter and to check the parameters.

2. Inquiry of the Information of Inverter

Graph	Setting	Run-Info	About
			Power 1230W
			E-Today 11.33 kWh
			E-Total 14.35 kWh
			T-Today 1.7 h
			T-Total 4.6 h
Normal	E-Today	11.33 kWh	15-07-09 15: 47

- In the main LCD interface, press “ENT” button, then press \blacktriangleright to enter into “About”.
- Press ENT to enter into “About” to check the equipment type, series number, machine code, software version of display panel, mainframe version of the control panel and the settings of country.

6.2.6 Self test of the Inverter

	LCD Display	Operation Steps																																												
	Self test																																													
Self test	<table border="1"> <thead> <tr> <th>Graph</th> <th>Setting</th> <th>Run-Info</th> <th>About</th> </tr> </thead> <tbody> <tr> <td><input checked="" type="radio"/></td> <td>Ovp (59.S2) test</td> <td></td> <td>Power 1230W</td> </tr> <tr> <td><input type="radio"/></td> <td>Ovp10 (59.S1) test</td> <td></td> <td>E-Today 11.33 kWh</td> </tr> <tr> <td><input type="radio"/></td> <td>Uvp (27.S1) test</td> <td></td> <td>E-Total 14.35 kWh</td> </tr> <tr> <td><input type="radio"/></td> <td>Uvp2 (27.S2) test</td> <td></td> <td>T-Today 1.7 h</td> </tr> <tr> <td><input type="radio"/></td> <td>Ofp (81>.S1) test</td> <td></td> <td>T-Total 4.6 h</td> </tr> <tr> <td><input type="radio"/></td> <td>Ofp2 (81>.S2) test</td> <td></td> <td></td> </tr> <tr> <td><input type="radio"/></td> <td>Ufp (81<.S1) test</td> <td></td> <td></td> </tr> <tr> <td><input type="radio"/></td> <td>Ufp2 (81<.S2) test</td> <td></td> <td></td> </tr> <tr> <td><input type="radio"/></td> <td>ALL test</td> <td><input type="button" value="Return"/></td> <td></td> </tr> <tr> <td>Normal</td> <td>E-Today</td> <td>11.33 kWh</td> <td>18-11-09 15: 47</td> </tr> </tbody> </table>	Graph	Setting	Run-Info	About	<input checked="" type="radio"/>	Ovp (59.S2) test		Power 1230W	<input type="radio"/>	Ovp10 (59.S1) test		E-Today 11.33 kWh	<input type="radio"/>	Uvp (27.S1) test		E-Total 14.35 kWh	<input type="radio"/>	Uvp2 (27.S2) test		T-Today 1.7 h	<input type="radio"/>	Ofp (81>.S1) test		T-Total 4.6 h	<input type="radio"/>	Ofp2 (81>.S2) test			<input type="radio"/>	Ufp (81<.S1) test			<input type="radio"/>	Ufp2 (81<.S2) test			<input type="radio"/>	ALL test	<input type="button" value="Return"/>		Normal	E-Today	11.33 kWh	18-11-09 15: 47	<p>Press “\blacktriangleleft”and“ENT” at the same time to enter Self Test.</p> <p>Note: 1.This setting only appears when the grid compliance selects Italy.</p> <p>2.This setting shall be operated when the inverter is under normal grid-connected state.</p>
	Graph	Setting	Run-Info	About																																										
<input checked="" type="radio"/>	Ovp (59.S2) test		Power 1230W																																											
<input type="radio"/>	Ovp10 (59.S1) test		E-Today 11.33 kWh																																											
<input type="radio"/>	Uvp (27.S1) test		E-Total 14.35 kWh																																											
<input type="radio"/>	Uvp2 (27.S2) test		T-Today 1.7 h																																											
<input type="radio"/>	Ofp (81>.S1) test		T-Total 4.6 h																																											
<input type="radio"/>	Ofp2 (81>.S2) test																																													
<input type="radio"/>	Ufp (81<.S1) test																																													
<input type="radio"/>	Ufp2 (81<.S2) test																																													
<input type="radio"/>	ALL test	<input type="button" value="Return"/>																																												
Normal	E-Today	11.33 kWh	18-11-09 15: 47																																											

Graph	Setting	Run-Info	About
<Ovp (59.S2) test>			Power 1230W
<input checked="" type="radio"/> Start Test <input type="radio"/> View Results			E-Today 11.33 kWh
			E-Total 14.35 kWh
			T-Today 1.7 h
			T-Total 4.6 h
<input type="button" value="Return"/>			
Normal	E-Today	11.33 kWh	18-11-09 15: 47

1. Select "Ovp (59.S2) test"; press "ENT" button to enter into setting.

Graph	Setting	Run-Info	About
<Ovp (59.S2) test>			Power 1230W
Testing, please wait. . .			E-Today 11.33 kWh
			E-Total 14.35 kWh
			T-Today 1.7 h
			T-Total 4.6 h
<input type="button" value="Return"/>			
Normal	E-Today	11.33 kWh	18-11-09 15: 47

2. Select "Start Test"; press "ENT" button to start test.

Graph	Setting	Run-Info	About
<Ovp (59.S2) results>			Power 1230W
Vt: 264.5V Vs: 221.8V Vo: 221.3V It: 200 ms To: 188 ms			E-Today 11.33 kWh
18/11/09 15: 23 Pass			E-Total 14.35 kWh
<input type="button" value="Next"/> <input type="button" value="Return"/>			T-Today 1.7 h
			T-Total 4.6 h
Normal	E-Today	11.33 kWh	18-11-09 15: 47

3. When Self-Test is completed, results will pop up automatically. You can also select "View Results" and press "ENT" to see the results. Note: Select "NEXT" and press "ENT", you can see the results of other testing items.

Over-voltage protection test of average voltage	<table border="1"> <thead> <tr> <th>Graph</th> <th>Setting</th> <th>Run-Info</th> <th>About</th> <th></th> </tr> </thead> <tbody> <tr> <td><input type="radio"/></td> <td>Ovp (59.S2) test</td> <td></td> <td></td> <td>Power 1230W</td> </tr> <tr> <td><input checked="" type="radio"/></td> <td>Ovp10 (59.S1) test</td> <td></td> <td></td> <td>E-Today 11.33 kWh</td> </tr> <tr> <td><input type="radio"/></td> <td>Uvp (27.S1) test</td> <td></td> <td></td> <td>E-Total 14.35 kWh</td> </tr> <tr> <td><input type="radio"/></td> <td>Uvp2 (27.S2) test</td> <td></td> <td></td> <td>T-Today 1.7 h</td> </tr> <tr> <td><input type="radio"/></td> <td>Ofp (81>.S1) test</td> <td></td> <td></td> <td>T-Total 4.6 h</td> </tr> <tr> <td><input type="radio"/></td> <td>Ofp2 (81>.S2) test</td> <td></td> <td></td> <td></td> </tr> <tr> <td><input type="radio"/></td> <td>Ufp (81<.S1) test</td> <td></td> <td></td> <td></td> </tr> <tr> <td><input type="radio"/></td> <td>Ufp2 (81<.S2) test</td> <td></td> <td></td> <td></td> </tr> <tr> <td><input type="radio"/></td> <td>ALL test</td> <td></td> <td><input type="button" value="Return"/></td> <td></td> </tr> <tr> <td>Normal</td> <td>E-Today 11.33 kWh</td> <td></td> <td>18-11-09</td> <td>15: 47</td> </tr> </tbody> </table>	Graph	Setting	Run-Info	About		<input type="radio"/>	Ovp (59.S2) test			Power 1230W	<input checked="" type="radio"/>	Ovp10 (59.S1) test			E-Today 11.33 kWh	<input type="radio"/>	Uvp (27.S1) test			E-Total 14.35 kWh	<input type="radio"/>	Uvp2 (27.S2) test			T-Today 1.7 h	<input type="radio"/>	Ofp (81>.S1) test			T-Total 4.6 h	<input type="radio"/>	Ofp2 (81>.S2) test				<input type="radio"/>	Ufp (81<.S1) test				<input type="radio"/>	Ufp2 (81<.S2) test				<input type="radio"/>	ALL test		<input type="button" value="Return"/>		Normal	E-Today 11.33 kWh		18-11-09	15: 47	<p>Press “▼” button, select “Ovp10 (59.S1) test” and press “ENT” button to enter into setting.</p> <p>Note: Follow the operation steps in item 1 to start test and view results.</p>
Graph	Setting	Run-Info	About																																																						
<input type="radio"/>	Ovp (59.S2) test			Power 1230W																																																					
<input checked="" type="radio"/>	Ovp10 (59.S1) test			E-Today 11.33 kWh																																																					
<input type="radio"/>	Uvp (27.S1) test			E-Total 14.35 kWh																																																					
<input type="radio"/>	Uvp2 (27.S2) test			T-Today 1.7 h																																																					
<input type="radio"/>	Ofp (81>.S1) test			T-Total 4.6 h																																																					
<input type="radio"/>	Ofp2 (81>.S2) test																																																								
<input type="radio"/>	Ufp (81<.S1) test																																																								
<input type="radio"/>	Ufp2 (81<.S2) test																																																								
<input type="radio"/>	ALL test		<input type="button" value="Return"/>																																																						
Normal	E-Today 11.33 kWh		18-11-09	15: 47																																																					
Under-voltage protection test	<table border="1"> <thead> <tr> <th>Graph</th> <th>Setting</th> <th>Run-Info</th> <th>About</th> <th></th> </tr> </thead> <tbody> <tr> <td><input type="radio"/></td> <td>Ovp (59.S2) test</td> <td></td> <td></td> <td>Power 1230W</td> </tr> <tr> <td><input type="radio"/></td> <td>Ovp10 (59.S1) test</td> <td></td> <td></td> <td>E-Today 11.33 kWh</td> </tr> <tr> <td><input checked="" type="radio"/></td> <td>Uvp (27.S1) test</td> <td></td> <td></td> <td>E-Total 14.35 kWh</td> </tr> <tr> <td><input type="radio"/></td> <td>Uvp2 (27.S2) test</td> <td></td> <td></td> <td>T-Today 1.7 h</td> </tr> <tr> <td><input type="radio"/></td> <td>Ofp (81>.S1) test</td> <td></td> <td></td> <td>T-Total 4.6 h</td> </tr> <tr> <td><input type="radio"/></td> <td>Ofp2 (81>.S2) test</td> <td></td> <td></td> <td></td> </tr> <tr> <td><input type="radio"/></td> <td>Ufp (81<.S1) test</td> <td></td> <td></td> <td></td> </tr> <tr> <td><input type="radio"/></td> <td>Ufp2 (81<.S2) test</td> <td></td> <td></td> <td></td> </tr> <tr> <td><input type="radio"/></td> <td>ALL test</td> <td></td> <td><input type="button" value="Return"/></td> <td></td> </tr> <tr> <td>Normal</td> <td>E-Today 11.33 kWh</td> <td></td> <td>18-11-09</td> <td>15: 47</td> </tr> </tbody> </table>	Graph	Setting	Run-Info	About		<input type="radio"/>	Ovp (59.S2) test			Power 1230W	<input type="radio"/>	Ovp10 (59.S1) test			E-Today 11.33 kWh	<input checked="" type="radio"/>	Uvp (27.S1) test			E-Total 14.35 kWh	<input type="radio"/>	Uvp2 (27.S2) test			T-Today 1.7 h	<input type="radio"/>	Ofp (81>.S1) test			T-Total 4.6 h	<input type="radio"/>	Ofp2 (81>.S2) test				<input type="radio"/>	Ufp (81<.S1) test				<input type="radio"/>	Ufp2 (81<.S2) test				<input type="radio"/>	ALL test		<input type="button" value="Return"/>		Normal	E-Today 11.33 kWh		18-11-09	15: 47	<p>Press “▼” button, select “Uvp (27.S1) test” and press “ENT” button to enter into setting.</p> <p>Note: Follow the operation steps in item 1 to start test and view results.</p>
Graph	Setting	Run-Info	About																																																						
<input type="radio"/>	Ovp (59.S2) test			Power 1230W																																																					
<input type="radio"/>	Ovp10 (59.S1) test			E-Today 11.33 kWh																																																					
<input checked="" type="radio"/>	Uvp (27.S1) test			E-Total 14.35 kWh																																																					
<input type="radio"/>	Uvp2 (27.S2) test			T-Today 1.7 h																																																					
<input type="radio"/>	Ofp (81>.S1) test			T-Total 4.6 h																																																					
<input type="radio"/>	Ofp2 (81>.S2) test																																																								
<input type="radio"/>	Ufp (81<.S1) test																																																								
<input type="radio"/>	Ufp2 (81<.S2) test																																																								
<input type="radio"/>	ALL test		<input type="button" value="Return"/>																																																						
Normal	E-Today 11.33 kWh		18-11-09	15: 47																																																					
Secondary under-voltage protection test	<table border="1"> <thead> <tr> <th>Graph</th> <th>Setting</th> <th>Run-Info</th> <th>About</th> <th></th> </tr> </thead> <tbody> <tr> <td><input type="radio"/></td> <td>Ovp (59.S2) test</td> <td></td> <td></td> <td>Power 1230W</td> </tr> <tr> <td><input type="radio"/></td> <td>Ovp10 (59.S1) test</td> <td></td> <td></td> <td>E-Today 11.33 kWh</td> </tr> <tr> <td><input type="radio"/></td> <td>Uvp (27.S1) test</td> <td></td> <td></td> <td>E-Total 14.35 kWh</td> </tr> <tr> <td><input checked="" type="radio"/></td> <td>Uvp2 (27.S2) test</td> <td></td> <td></td> <td>T-Today 1.7 h</td> </tr> <tr> <td><input type="radio"/></td> <td>Ofp (81>.S1) test</td> <td></td> <td></td> <td>T-Total 4.6 h</td> </tr> <tr> <td><input type="radio"/></td> <td>Ofp2 (81>.S2) test</td> <td></td> <td></td> <td></td> </tr> <tr> <td><input type="radio"/></td> <td>Ufp (81<.S1) test</td> <td></td> <td></td> <td></td> </tr> <tr> <td><input type="radio"/></td> <td>Ufp2 (81<.S2) test</td> <td></td> <td></td> <td></td> </tr> <tr> <td><input type="radio"/></td> <td>ALL test</td> <td></td> <td><input type="button" value="Return"/></td> <td></td> </tr> <tr> <td>Normal</td> <td>E-Today 11.33 kWh</td> <td></td> <td>18-11-09</td> <td>15: 47</td> </tr> </tbody> </table>	Graph	Setting	Run-Info	About		<input type="radio"/>	Ovp (59.S2) test			Power 1230W	<input type="radio"/>	Ovp10 (59.S1) test			E-Today 11.33 kWh	<input type="radio"/>	Uvp (27.S1) test			E-Total 14.35 kWh	<input checked="" type="radio"/>	Uvp2 (27.S2) test			T-Today 1.7 h	<input type="radio"/>	Ofp (81>.S1) test			T-Total 4.6 h	<input type="radio"/>	Ofp2 (81>.S2) test				<input type="radio"/>	Ufp (81<.S1) test				<input type="radio"/>	Ufp2 (81<.S2) test				<input type="radio"/>	ALL test		<input type="button" value="Return"/>		Normal	E-Today 11.33 kWh		18-11-09	15: 47	<p>Press “▼” button, select “Uvp2 (27.S2) test” and press “ENT” button to enter into setting.</p> <p>Note: Follow the operation steps in item 1 to start test and view results.</p>
Graph	Setting	Run-Info	About																																																						
<input type="radio"/>	Ovp (59.S2) test			Power 1230W																																																					
<input type="radio"/>	Ovp10 (59.S1) test			E-Today 11.33 kWh																																																					
<input type="radio"/>	Uvp (27.S1) test			E-Total 14.35 kWh																																																					
<input checked="" type="radio"/>	Uvp2 (27.S2) test			T-Today 1.7 h																																																					
<input type="radio"/>	Ofp (81>.S1) test			T-Total 4.6 h																																																					
<input type="radio"/>	Ofp2 (81>.S2) test																																																								
<input type="radio"/>	Ufp (81<.S1) test																																																								
<input type="radio"/>	Ufp2 (81<.S2) test																																																								
<input type="radio"/>	ALL test		<input type="button" value="Return"/>																																																						
Normal	E-Today 11.33 kWh		18-11-09	15: 47																																																					
Over-frequency protection test	<table border="1"> <thead> <tr> <th>Graph</th> <th>Setting</th> <th>Run-Info</th> <th>About</th> <th></th> </tr> </thead> <tbody> <tr> <td><input type="radio"/></td> <td>Ovp (59.S2) test</td> <td></td> <td></td> <td>Power 1230W</td> </tr> <tr> <td><input type="radio"/></td> <td>Ovp10 (59.S1) test</td> <td></td> <td></td> <td>E-Today 11.33 kWh</td> </tr> <tr> <td><input type="radio"/></td> <td>Uvp (27.S1) test</td> <td></td> <td></td> <td>E-Total 14.35 kWh</td> </tr> <tr> <td><input type="radio"/></td> <td>Uvp2 (27.S2) test</td> <td></td> <td></td> <td>T-Today 1.7 h</td> </tr> <tr> <td><input checked="" type="radio"/></td> <td>Ofp (81>.S1) test</td> <td></td> <td></td> <td>T-Total 4.6 h</td> </tr> <tr> <td><input type="radio"/></td> <td>Ofp2 (81>.S2) test</td> <td></td> <td></td> <td></td> </tr> <tr> <td><input type="radio"/></td> <td>Ufp (81<.S1) test</td> <td></td> <td></td> <td></td> </tr> <tr> <td><input type="radio"/></td> <td>Ufp2 (81<.S2) test</td> <td></td> <td></td> <td></td> </tr> <tr> <td><input type="radio"/></td> <td>ALL test</td> <td></td> <td><input type="button" value="Return"/></td> <td></td> </tr> <tr> <td>Normal</td> <td>E-Today 11.33 kWh</td> <td></td> <td>18-11-09</td> <td>15: 47</td> </tr> </tbody> </table>	Graph	Setting	Run-Info	About		<input type="radio"/>	Ovp (59.S2) test			Power 1230W	<input type="radio"/>	Ovp10 (59.S1) test			E-Today 11.33 kWh	<input type="radio"/>	Uvp (27.S1) test			E-Total 14.35 kWh	<input type="radio"/>	Uvp2 (27.S2) test			T-Today 1.7 h	<input checked="" type="radio"/>	Ofp (81>.S1) test			T-Total 4.6 h	<input type="radio"/>	Ofp2 (81>.S2) test				<input type="radio"/>	Ufp (81<.S1) test				<input type="radio"/>	Ufp2 (81<.S2) test				<input type="radio"/>	ALL test		<input type="button" value="Return"/>		Normal	E-Today 11.33 kWh		18-11-09	15: 47	<p>Press “▼” button, select “Ufp (81>.S1) test” and press “ENT” button to enter into setting.</p> <p>Note: Follow the operation steps in item 1 to start test and view results.</p>
Graph	Setting	Run-Info	About																																																						
<input type="radio"/>	Ovp (59.S2) test			Power 1230W																																																					
<input type="radio"/>	Ovp10 (59.S1) test			E-Today 11.33 kWh																																																					
<input type="radio"/>	Uvp (27.S1) test			E-Total 14.35 kWh																																																					
<input type="radio"/>	Uvp2 (27.S2) test			T-Today 1.7 h																																																					
<input checked="" type="radio"/>	Ofp (81>.S1) test			T-Total 4.6 h																																																					
<input type="radio"/>	Ofp2 (81>.S2) test																																																								
<input type="radio"/>	Ufp (81<.S1) test																																																								
<input type="radio"/>	Ufp2 (81<.S2) test																																																								
<input type="radio"/>	ALL test		<input type="button" value="Return"/>																																																						
Normal	E-Today 11.33 kWh		18-11-09	15: 47																																																					

Secondary over-frequency protection test	<table border="1"> <thead> <tr> <th>Graph</th> <th>Setting</th> <th>Run-Info</th> <th>About</th> <th></th> </tr> </thead> <tbody> <tr> <td><input type="radio"/></td> <td>Ovp (59.S2) test</td> <td></td> <td></td> <td>Power 1230W</td> </tr> <tr> <td><input type="radio"/></td> <td>Ovp10 (59.S1) test</td> <td></td> <td></td> <td>E-Today 11.33 kWh</td> </tr> <tr> <td><input type="radio"/></td> <td>Uvp (27.S1) test</td> <td></td> <td></td> <td>E-Total 14.35 kWh</td> </tr> <tr> <td><input type="radio"/></td> <td>Uvp2 (27.S2) test</td> <td></td> <td></td> <td>T-Today 1.7 h</td> </tr> <tr> <td><input type="radio"/></td> <td>Ofp (81>.S1) test</td> <td></td> <td></td> <td>T-Total 4.6 h</td> </tr> <tr> <td><input checked="" type="radio"/></td> <td>Ofp2 (81>.S2) test</td> <td></td> <td></td> <td></td> </tr> <tr> <td><input type="radio"/></td> <td>Ufp (81<.S1) test</td> <td></td> <td></td> <td></td> </tr> <tr> <td><input type="radio"/></td> <td>Ufp2 (81<.S2) test</td> <td></td> <td></td> <td></td> </tr> <tr> <td><input type="radio"/></td> <td>ALL test</td> <td></td> <td><input type="button" value="Return"/></td> <td></td> </tr> <tr> <td>Normal</td> <td>E-Today</td> <td>11.33 kWh</td> <td>18-11-09</td> <td>15: 47</td> </tr> </tbody> </table>	Graph	Setting	Run-Info	About		<input type="radio"/>	Ovp (59.S2) test			Power 1230W	<input type="radio"/>	Ovp10 (59.S1) test			E-Today 11.33 kWh	<input type="radio"/>	Uvp (27.S1) test			E-Total 14.35 kWh	<input type="radio"/>	Uvp2 (27.S2) test			T-Today 1.7 h	<input type="radio"/>	Ofp (81>.S1) test			T-Total 4.6 h	<input checked="" type="radio"/>	Ofp2 (81>.S2) test				<input type="radio"/>	Ufp (81<.S1) test				<input type="radio"/>	Ufp2 (81<.S2) test				<input type="radio"/>	ALL test		<input type="button" value="Return"/>		Normal	E-Today	11.33 kWh	18-11-09	15: 47	<p>Press “▼” button, select “Ufp2 (81>.S2) test” and press “ENT” button to enter into setting.</p> <p>Note: Follow the operation steps in item 1 to start test and view results.</p>
Graph	Setting	Run-Info	About																																																						
<input type="radio"/>	Ovp (59.S2) test			Power 1230W																																																					
<input type="radio"/>	Ovp10 (59.S1) test			E-Today 11.33 kWh																																																					
<input type="radio"/>	Uvp (27.S1) test			E-Total 14.35 kWh																																																					
<input type="radio"/>	Uvp2 (27.S2) test			T-Today 1.7 h																																																					
<input type="radio"/>	Ofp (81>.S1) test			T-Total 4.6 h																																																					
<input checked="" type="radio"/>	Ofp2 (81>.S2) test																																																								
<input type="radio"/>	Ufp (81<.S1) test																																																								
<input type="radio"/>	Ufp2 (81<.S2) test																																																								
<input type="radio"/>	ALL test		<input type="button" value="Return"/>																																																						
Normal	E-Today	11.33 kWh	18-11-09	15: 47																																																					
Under-frequency protection test	<table border="1"> <thead> <tr> <th>Graph</th> <th>Setting</th> <th>Run-Info</th> <th>About</th> <th></th> </tr> </thead> <tbody> <tr> <td><input type="radio"/></td> <td>Ovp (59.S2) test</td> <td></td> <td></td> <td>Power 1230W</td> </tr> <tr> <td><input type="radio"/></td> <td>Ovp10 (59.S1) test</td> <td></td> <td></td> <td>E-Today 11.33 kWh</td> </tr> <tr> <td><input type="radio"/></td> <td>Uvp (27.S1) test</td> <td></td> <td></td> <td>E-Total 14.35 kWh</td> </tr> <tr> <td><input type="radio"/></td> <td>Uvp2 (27.S2) test</td> <td></td> <td></td> <td>T-Today 1.7 h</td> </tr> <tr> <td><input type="radio"/></td> <td>Ofp (81>.S1) test</td> <td></td> <td></td> <td>T-Total 4.6 h</td> </tr> <tr> <td><input type="radio"/></td> <td>Ofp2 (81>.S2) test</td> <td></td> <td></td> <td></td> </tr> <tr> <td><input checked="" type="radio"/></td> <td>Ufp (81<.S1) test</td> <td></td> <td></td> <td></td> </tr> <tr> <td><input type="radio"/></td> <td>Ufp2 (81<.S2) test</td> <td></td> <td></td> <td></td> </tr> <tr> <td><input type="radio"/></td> <td>ALL test</td> <td></td> <td><input type="button" value="Return"/></td> <td></td> </tr> <tr> <td>Normal</td> <td>E-Today</td> <td>11.33 kWh</td> <td>18-11-09</td> <td>15: 47</td> </tr> </tbody> </table>	Graph	Setting	Run-Info	About		<input type="radio"/>	Ovp (59.S2) test			Power 1230W	<input type="radio"/>	Ovp10 (59.S1) test			E-Today 11.33 kWh	<input type="radio"/>	Uvp (27.S1) test			E-Total 14.35 kWh	<input type="radio"/>	Uvp2 (27.S2) test			T-Today 1.7 h	<input type="radio"/>	Ofp (81>.S1) test			T-Total 4.6 h	<input type="radio"/>	Ofp2 (81>.S2) test				<input checked="" type="radio"/>	Ufp (81<.S1) test				<input type="radio"/>	Ufp2 (81<.S2) test				<input type="radio"/>	ALL test		<input type="button" value="Return"/>		Normal	E-Today	11.33 kWh	18-11-09	15: 47	<p>Press “▼” button, select “Ufp (81<.S1) test” and press “ENT” button to enter into setting.</p> <p>Note: Follow the operation steps in item 1 to start test and view results.</p>
Graph	Setting	Run-Info	About																																																						
<input type="radio"/>	Ovp (59.S2) test			Power 1230W																																																					
<input type="radio"/>	Ovp10 (59.S1) test			E-Today 11.33 kWh																																																					
<input type="radio"/>	Uvp (27.S1) test			E-Total 14.35 kWh																																																					
<input type="radio"/>	Uvp2 (27.S2) test			T-Today 1.7 h																																																					
<input type="radio"/>	Ofp (81>.S1) test			T-Total 4.6 h																																																					
<input type="radio"/>	Ofp2 (81>.S2) test																																																								
<input checked="" type="radio"/>	Ufp (81<.S1) test																																																								
<input type="radio"/>	Ufp2 (81<.S2) test																																																								
<input type="radio"/>	ALL test		<input type="button" value="Return"/>																																																						
Normal	E-Today	11.33 kWh	18-11-09	15: 47																																																					
Secondary under-frequency	<table border="1"> <thead> <tr> <th>Graph</th> <th>Setting</th> <th>Run-Info</th> <th>About</th> <th></th> </tr> </thead> <tbody> <tr> <td><input type="radio"/></td> <td>Ovp (59.S2) test</td> <td></td> <td></td> <td>Power 1230W</td> </tr> <tr> <td><input type="radio"/></td> <td>Ovp10 (59.S1) test</td> <td></td> <td></td> <td>E-Today 11.33 kWh</td> </tr> <tr> <td><input type="radio"/></td> <td>Uvp (27.S1) test</td> <td></td> <td></td> <td>E-Total 14.35 kWh</td> </tr> <tr> <td><input type="radio"/></td> <td>Uvp2 (27.S2) test</td> <td></td> <td></td> <td>T-Today 1.7 h</td> </tr> <tr> <td><input type="radio"/></td> <td>Ofp (81>.S1) test</td> <td></td> <td></td> <td>T-Total 4.6 h</td> </tr> <tr> <td><input type="radio"/></td> <td>Ofp2 (81>.S2) test</td> <td></td> <td></td> <td></td> </tr> <tr> <td><input type="radio"/></td> <td>Ufp (81<.S1) test</td> <td></td> <td></td> <td></td> </tr> <tr> <td><input checked="" type="radio"/></td> <td>Ufp2 (81<.S2) test</td> <td></td> <td></td> <td></td> </tr> <tr> <td><input type="radio"/></td> <td>ALL test</td> <td></td> <td><input type="button" value="Return"/></td> <td></td> </tr> <tr> <td>Normal</td> <td>E-Today</td> <td>11.33 kWh</td> <td>18-11-09</td> <td>15: 47</td> </tr> </tbody> </table>	Graph	Setting	Run-Info	About		<input type="radio"/>	Ovp (59.S2) test			Power 1230W	<input type="radio"/>	Ovp10 (59.S1) test			E-Today 11.33 kWh	<input type="radio"/>	Uvp (27.S1) test			E-Total 14.35 kWh	<input type="radio"/>	Uvp2 (27.S2) test			T-Today 1.7 h	<input type="radio"/>	Ofp (81>.S1) test			T-Total 4.6 h	<input type="radio"/>	Ofp2 (81>.S2) test				<input type="radio"/>	Ufp (81<.S1) test				<input checked="" type="radio"/>	Ufp2 (81<.S2) test				<input type="radio"/>	ALL test		<input type="button" value="Return"/>		Normal	E-Today	11.33 kWh	18-11-09	15: 47	<p>Press “▼” button, select “Ufp2 (81<.S2) test” and press “ENT” button to enter into setting.</p> <p>Note: Follow the operation steps in item 1 to start test and view results.</p>
Graph	Setting	Run-Info	About																																																						
<input type="radio"/>	Ovp (59.S2) test			Power 1230W																																																					
<input type="radio"/>	Ovp10 (59.S1) test			E-Today 11.33 kWh																																																					
<input type="radio"/>	Uvp (27.S1) test			E-Total 14.35 kWh																																																					
<input type="radio"/>	Uvp2 (27.S2) test			T-Today 1.7 h																																																					
<input type="radio"/>	Ofp (81>.S1) test			T-Total 4.6 h																																																					
<input type="radio"/>	Ofp2 (81>.S2) test																																																								
<input type="radio"/>	Ufp (81<.S1) test																																																								
<input checked="" type="radio"/>	Ufp2 (81<.S2) test																																																								
<input type="radio"/>	ALL test		<input type="button" value="Return"/>																																																						
Normal	E-Today	11.33 kWh	18-11-09	15: 47																																																					
All test	<table border="1"> <thead> <tr> <th>Graph</th> <th>Setting</th> <th>Run-Info</th> <th>About</th> <th></th> </tr> </thead> <tbody> <tr> <td><input type="radio"/></td> <td>Ovp (59.S2) test</td> <td></td> <td></td> <td>Power 1230W</td> </tr> <tr> <td><input type="radio"/></td> <td>Ovp10 (59.S1) test</td> <td></td> <td></td> <td>E-Today 11.33 kWh</td> </tr> <tr> <td><input type="radio"/></td> <td>Uvp (27.S1) test</td> <td></td> <td></td> <td>E-Total 14.35 kWh</td> </tr> <tr> <td><input type="radio"/></td> <td>Uvp2 (27.S2) test</td> <td></td> <td></td> <td>T-Today 1.7 h</td> </tr> <tr> <td><input type="radio"/></td> <td>Ofp (81>.S1) test</td> <td></td> <td></td> <td>T-Total 4.6 h</td> </tr> <tr> <td><input type="radio"/></td> <td>Ofp2 (81>.S2) test</td> <td></td> <td></td> <td></td> </tr> <tr> <td><input type="radio"/></td> <td>Ufp (81<.S1) test</td> <td></td> <td></td> <td></td> </tr> <tr> <td><input type="radio"/></td> <td>Ufp2 (81<.S2) test</td> <td></td> <td></td> <td></td> </tr> <tr> <td><input checked="" type="radio"/></td> <td>ALL test</td> <td></td> <td><input type="button" value="Return"/></td> <td></td> </tr> <tr> <td>Normal</td> <td>E-Today</td> <td>11.33 kWh</td> <td>18-11-09</td> <td>15: 47</td> </tr> </tbody> </table>	Graph	Setting	Run-Info	About		<input type="radio"/>	Ovp (59.S2) test			Power 1230W	<input type="radio"/>	Ovp10 (59.S1) test			E-Today 11.33 kWh	<input type="radio"/>	Uvp (27.S1) test			E-Total 14.35 kWh	<input type="radio"/>	Uvp2 (27.S2) test			T-Today 1.7 h	<input type="radio"/>	Ofp (81>.S1) test			T-Total 4.6 h	<input type="radio"/>	Ofp2 (81>.S2) test				<input type="radio"/>	Ufp (81<.S1) test				<input type="radio"/>	Ufp2 (81<.S2) test				<input checked="" type="radio"/>	ALL test		<input type="button" value="Return"/>		Normal	E-Today	11.33 kWh	18-11-09	15: 47	<p>Press “▼” button, select “ALL test” and press “ENT” button to enter into setting.</p> <p>Note: 1. The detection operation is the same as the item 1. 2. “All test” is starting from</p>
Graph	Setting	Run-Info	About																																																						
<input type="radio"/>	Ovp (59.S2) test			Power 1230W																																																					
<input type="radio"/>	Ovp10 (59.S1) test			E-Today 11.33 kWh																																																					
<input type="radio"/>	Uvp (27.S1) test			E-Total 14.35 kWh																																																					
<input type="radio"/>	Uvp2 (27.S2) test			T-Today 1.7 h																																																					
<input type="radio"/>	Ofp (81>.S1) test			T-Total 4.6 h																																																					
<input type="radio"/>	Ofp2 (81>.S2) test																																																								
<input type="radio"/>	Ufp (81<.S1) test																																																								
<input type="radio"/>	Ufp2 (81<.S2) test																																																								
<input checked="" type="radio"/>	ALL test		<input type="button" value="Return"/>																																																						
Normal	E-Today	11.33 kWh	18-11-09	15: 47																																																					

		<p>the item 1 to item 8 of the autotest.</p> <p>3. When test is completed, results will be viewed from item 1.</p>
--	--	--

Attention:

1. If any item is not tested, results will be as below:

Graph	Setting	Run-Info	About	
<Ovp (59.S2) test> No Result ! <input type="button" value="Next"/> <input type="button" value="Return"/>				Power 1230W
				E-Today 11.33 kWh
				E-Total 14.35 kWh
				T-Today 1.7 h
				T-Total 4.6 h
Normal	E-Today	11.33 kWh	18-11-09	15: 47

2.If any item fails the test, results will be as below:

Graph	Setting	Run-Info	About	
<Ovp (59.S2) test> Test failed ! <input type="button" value="Next"/> <input type="button" value="Return"/>				Power 1230W
				E-Today 11.33 kWh
				E-Total 14.35 kWh
				T-Today 1.7 h
				T-Total 4.6 h
Normal	E-Today	11.33 kWh	18-11-09	15: 47

6.3 Monitoring Operation

The equipment is equipped with a RS232 and a RS485 interface, and the RS232 interface can be connected to Wi-Fi module, Ethernet module, GPRS module which can be used in the monitoring of the operation status.

①By connecting the Internet through Wi-Fi module and uploading the inverter data to the server, users can monitor the operational information of the inverter by web version web portal or mobile APP (please download the mobile APP from SAJ official website) remotely.

②By connecting the Internet through Ethernet module and uploading the inverter data to the server, users can monitor the operational information of the inverter by web version web portal or mobile APP (please download the mobile APP from SAJ official website) remotely.

③By connecting the Internet through GPRS module and uploading inverter data to the server, users can monitor the operational information of the inverter by web version web portal or mobile APP (please download the mobile APP from SAJ official website) remotely.

Users can apply a Modbus protocol through RS485 together with a SAJ Logger to monitor the data of the inverter. For detailed operation please refer to the SAJ Logger User Manual.

Chapter 7 Fault Code and Troubleshooting

LCD displays Fault codes as shown in the table below:

Error Code	Explanation
01	Relay Error Master
02	Storer Error Master
03	High Temperature Master
04	Low Temperature Master
05	Lost Interior Communication Master
06	GFCI Devices Error Master
07	DCI Devices Error Master
08	Current Sensor Master
09/11/13	L1/L2/L3 Voltage High Master
10/12/14	L1/L2/L3 Voltage Low Master
15/16/17	L1/L2/L3 Average Voltage of 10 minutes High Master
18/20/22	L1/L2/L3 Frequency High Master
19/21/23	L1/L2/L3 Frequency Low Master
24/25/26	L1/L2/L3 Grid Lost Error Master
27	GFCI Error Master
28/29/30	L1/L2/L3 DCI Error Master
31	Insulation Error Master
32	Bus Voltage Unbalance Master
33	Bus Voltage High Master
34	Bus Voltage Low Master
35/36/37	L1/L2/L3 Current High Master
38	Bus Voltage High Of Hardware Master
39/40	PV1/PV2,PV3 Current High of Hardware Master
41/42/43	L1/L2/L3 Current High of Hardware of Grid Master
45/46/47/48	Fan 1/2/3/4 Error Master
50	Lost interior communication Slave
51/52/53	L1/L2/L3 Data Consistency of Voltage Error Slave
54/55/56	L1/L2/L3 Data Consistency of Frequency Error Slave

57	Data Consistency of GFCI Slave
58/59/60	L1/L2/L3 Data Consistency of DCI Slave
61/63/65	L1/L2/L3 Grid Voltage High Slave
62/64/66	L1/L2/L3 Grid Voltage Low Slave
67/69/71	L1/L2/L3 Frequency High Slave
68/70/72	L1/L2/L3 Frequency Low Slave
73/74/75	L1/L2/L3 No Grid Error Slave
76/77/80	PV1 /PV2/PV3 Voltage High Slave
78/79/82	PV1/PV2/PV3 Current High Slave
81	Lost Communication Between Display board & Control board Master
83	Grounding detect Error Master
84	PV Input Error Master

Table7.1 Error Code

General troubleshooting methods for inverter are as follows:

Table 7.2 Troubleshooting

Error	Troubleshooting
Relay Error	If this error occurs frequently, please contact your distributor or phone SAJ.
Storer Error	If this error occurs frequently, please contact your distributor or phone SAJ.
Temperature High Error	Check whether the radiator is blocked, whether the inverter is in too high or too low temperature, if the above mentioned are in normal, please contact your distributor or phone SAJ.
GFCI Device Error	If this error occurs frequently, please contact your distributor or phone SAJ.
DCI Device Error	If this error occurs frequently, please contact your distributor or phone SAJ.
Current Sensor Error	If this error occurs frequently, please contact your distributor or phone SAJ.
AC Voltage Error	<ul style="list-style-type: none"> ·Check the connection between the inverter and the grid. ·Check the settings of the on-grid standards of the inverter. ·If the volt of the grid is higher than the volt regulated by local grid, please inquire the local grid workers whether they can adjust the volt at the feed point or change the value of the regulated volt.

	·If the voltage of the grid is in regulated range as allowed and LCD still in this error, please contact your distributor or phone SAJ.
Frequency Error	Check the set of country and check the frequency of the local grid, if the above mentioned is in normal, please contact your distributor or phone SAJ.
No Grid Error	Check the connection status between the AC side of the inverter and the grid, if the above mentioned are in normal, please contact your distributor or phone SAJ.
GFCI Error	Check the insulation resistance of the positive side and negative side of the solar panel; check whether the inverter is in wet environment; check the grounding of the inverter. If the above-mentioned are in normal, please contact your distributor or phone SAJ.
DCI Error	If this error exists always, please contact your distributor or phone SAJ.
ISO Error	Check the insulation resistance of the positive side and negative side of the solar panel; check whether the inverter is in wet environment; check whether the grounding of the inverter is loose or not. If the above-mentioned are in normal, please contact your distributor or phone SAJ.
Current High	Check the connection status between the inverter and the grid and test whether the volt of the grid is stable or not, if the above-mentioned are in normal, please contact your distributor or phone SAJ.
Bus Voltage High	Check the settings of the solar panel. SAJ's system design software can help you. If the above-mentioned are in normal, please contact your distributor or phone SAJ.
PV Current High	If this error exists always, please contact your distributor or phone SAJ.
PV Voltage Fault	Check the settings of the solar panel. SAJ's system design software can help you. If the above-mentioned are in normal, please contact your distributor or phone SAJ.
Lost Communication	Check the connection of communication cables between control board and display board. If the above mentioned are in normal, please contact your distributor or phone SAJ.
Grounding detect Error	Check Grid phase line connects to ground or not. If the above-mentioned are in normal, please contact your distributor or phone SAJ.

PV Input Error

Check PV mode setting is right or not. If the above-mentioned are in normal, please contact your distributor or phone SAJ.

Chapter 8 Recycling and Disposal

This device should not be disposed as residential waste. An Inverter that has reached the end of its life and is not required is to be returned to your dealer or you must find an approved collection and recycling facility in your area.

Chapter 9 Guarantee Service

Please refer to the warranty card.

Chapter 10 Contact SAJ

Guangzhou Sanjing Electric Co., Ltd.

SAJ Innovation Park, No.9, Lizhishan Road, Guangzhou Science City,
Guangdong, P.R.China.

Postcode: 510663

Web: <http://www.saj-electric.com>

Technical Support & Service

Tel: +86 20 6660 8588

Fax: +86 20 6660 8589

E-mail: service@saj-electric.com

International Sales

Tel: +86 20 6660 8618/6660 8619/6660 8588/6660 0086

Fax: +86 020 6660 8589

E-mail: info@saj-electric.com

Domestic Sales

Tel: 020-66600058/66608588

Fax: 020-66608589

SAJ Warranty Policy

Standard Warranty Period

Guangzhou Sanjing Electric, Co., Ltd (“SAJ”) grants a standard warranty period of 66 months (5.5 years) for the Sununo-TL Series inverters & Suntrio-TL Series inverters and Sununo Plus Series inverters & Suntrio Plus Series inverters, starting from the date of shipment from SAJ factory or 60 months (5 years) starting from the date of purchased invoice marked (whichever is longer).

Extension of Warranty

The purchaser of SAJ inverters (Sununo-TL Series inverters & Suntrio-TL Series inverters and Sununo Plus Series inverters & Suntrio Plus Series inverters) should extend the warranty period in 18 months from the date of settlement or 30 months from the date of shipment from SAJ by providing the serial number of the unit and purchased receipt (whichever is shorter). You can purchase the warranty extension for 10 years, 15 years, 20 years or 25 years but do not apply the extension beyond the specified date, or else your application will be unacceptable. Please refer to the Warranty Extension Order Form for more details.

Once the purchase of the warranty extension goes into effect, SAJ will send the warranty extension certificate to the customer for confirming the extended warranty period.

Warranty Conditions

If your inverter gets fault and requires troubleshooting, please contact your distributor or dealer directly. Alternatively, feedback briefly to SAJ service hotline for logging and send your warranty card to our service department by

fax/email to process the warranty claim.

During the Warranty Period, SAJ covers all costs for replacing any product or parts of the product proved to be defective in design or manufacture. To claim the warranty under the warranty policy of SAJ, you need to supply us with the following information and documentation regarding the faulty inverter:

1.Product Model No.(e.g. Suntrio Plus 20K) and serial number.

(e.g.22030G1825EN00001)

2. Copy of the invoice and warranty certificate of the inverter.

3. Copy of the installation report and installation date.

4.Error message on LCD screen (if available) or any information which would be

helpful to determine the defect.

5.Detailed information about the entire system (modules, circuits, etc.).

6.Documentation of previous claims/exchanges (if applicable).

After receiving above information, SAJ will decide how to proceed the service

1.Repaired by SAJ factory, or SAJ authorized service center overhaul.

2.Repaired on-site by SAJ Service Center.

3. Offer a replacement device of equivalent value according to model and age.

In the case of an exchange, the remaining portion of the original warranty period will be transferred to the replacement device. You will not receive a new certificate, as your entitlement is documented at SAJ.

If the inverter needs to be replaced following assessment, SAJ will send a replacement unit immediately. The defective inverter should be sent back to

the closest SAJ Service Center by packing in its original package if possible.

Service after warranty expiration

If the inverters for maintenance are out of warranty, SAJ charges an on-site service fee, parts, labor cost and logistic fee to end-user. Detailed standard refers to the listed table.

Item	Return Factory Maintenance	On-site Maintenance
Without parts replacement	Labor + Logistic fee (to & from SAJ)	Labor + On-site attendance fee
With parts replacement	Labor + Parts + logistic fee (to & from SAJ)	Labor + On-site attendance fee + Parts

- On-site attendance fee: Cost of travel and time for the technician in attending on-site.
- Parts: Cost of replacement parts (including any shipping/admin fee that may apply).
- Labor: Labor time fee charged for the technician, who is repairing, maintaining, installing (hardware or software) and debugging the faulty product.
- Logistic fee: Cost of delivery, tariff and other derived expense when defective products are sent from user to SAJ or/and repaired products are sent from SAJ to user.

Exclusion of Liability

Any defect caused by the following circumstances will not be covered by the manufacturer's warranty (the Dealers or Distributors are responsible and authorized by SAJ for the following investigation):

- ◆ "Warranty Card" not being sent back to Distributor/Dealer or SAJ;
- ◆ Product modified, parts replaced or attempt to maintain;
- ◆ Changes, or attempted repairs and erasing of series number or seals by non SAJ technician;
- ◆ Incorrect installation or commissioning;
- ◆ Failure to comply with the safety regulations (VDE standards, etc.);
- ◆ The inverter has been improperly stored and damaged while being stored by the Dealer or the end user;
- ◆ Transport damage (including scratch caused by movement inside packaging during shipping).A Claim should be made directly to shipping company/insurance Company as soon as the container/packaging is unloaded and such damage is identified;
- ◆ Failure to follow any / all of the user manual, the installation guide and the maintenance regulations;
- ◆ Improper use or misuse of the inverter;
- ◆ Insufficient ventilation of the inverter;
- ◆ Influence of foreign objects and force majeure (lightning, grid overvoltage, severe weather, fire, etc.)
- ◆ For further information on SAJ warranty regulation and reliability, please visit our website: www.saj-electric.com.

Warranty Card

The installer should fill in the second form while installing the inverter. For warranty claim, please complete the below forms and send this page to SAJ attached with the Customer's invoice.

For Customer to fill in

Name:		
City:	Country:	Zip:
Tel:	Fax:	E-mail:

Information on Device

Device type:	Serial No.(S/N):
Invoice No:	Commissioning date::
Fault time:	
Error message (Display reading):	
Brief fault description & photo:	
Signature: _____ Date:	

For Installer to fill in

Modules Used:		
Modules Per String:	No. of String:	
Installation Company:	Contractor License Number:	
Company:		
City:	Country:	Zip:
Tel:	Fax:	E-mail:
Signature: _____		Date:



Guangzhou Sanjing Electric CO., LTD.

ADD: SAJ Innovation Park, No.9, Lizhishan Road, Science City,
Guangzhou High-tech Zone, Guangdong, P.R.China

Zip: 510663 Tel: +86 20 6660 8588 Fax: 020-6660 8589

Web: <http://www.saj-electric.com>

*Due to the continuous improvement of products, technical parameters in this manual are modified without prior notice.