



User Manual

SAJ Solar Inverter

R5-0.7K/1K/1.5K/2K/2.5K/3K-S1
R5-3K/3.6K/4K/5K/6K/7K/8K-S2
R5-0.7K/1K/1.5K/2K/2.5K/3K-S1-15
R5-3K/3.6K/4K/5K/6K/7K/8K-S2-15



Preface

Thank you for choosing SAJ solar inverter. We are pleased to provide you first-class products and exceptional service.

This manual includes information for installation, operation, maintenance, trouble shooting and safety. Please follow the instructions of this manual so that we can ensure delivery of our professional guidance and wholehearted service.

Customer-orientation is our forever commitment. We hope this document proves to be of great assistance in your journey for a cleaner, greener world.

Please check for the latest version at www.saj-electric.com

Guangzhou Sanjing Electric Co., Ltd.

Building e-Energy Management Solution Provider

Content

PREFACE	- 1 -
CHAPTER 1 SAFETY PRECAUTIONS.....	- 4 -
1.1 SCOPE OF APPLICATION.....	- 4 -
1.2 SAFETY INSTRUCTIONS.....	- 4 -
1.3 TARGET GROUP	- 5 -
CHAPTER 2 PREPARATION.....	- 5 -
2.1 SAFETY INSTRUCTIONS.....	- 5 -
2.2 EXPLANATIONS OF SYMBOLS.....	- 7 -
CHAPTER 3 PRODUCT INFORMATION.....	- 8 -
3.1 APPLICATION SCOPE OF PRODUCTS	- 8 -
3.2 SPECIFICATION FOR PRODUCT MODEL.....	- 9 -
3.3 OVERVIEW OF PRODUCTS.....	- 9 -
3.4 DATASHEET	- 11 -
CHAPTER 4 INSTRUCTIONS FOR INSTALLATION.....	- 29 -
4.1 SAFETY INSTRUCTIONS.....	- 29 -
4.2 PRE-INSTALLATION CHECK.....	- 29 -
4.3 THE DETERMINATION OF THE INSTALLATION METHOD AND POSITION..	- 30 -
4.4 MOUNTING PROCEDURE	- 31 -
CHAPTER 5 ELECTRICAL CONNECTION.....	- 36 -
5.1 SAFETY INSTRUCTION FOR HOT-LINE JOB	- 36 -
5.2 SPECIFICATIONS FOR ELECTRICAL INTERFACE	- 37 -
5.3 AC CONNECTION	- 41 -

5.4 DC SIDE CONNECTION	- 46 -
5.5 COMMUNICATION CONNECTION	- 48 -
CHAPTER 6 DEBUGGING INSTRUCTIONS.....	- 51 -
6.1 INTRODUCTION OF HUMAN-COMPUTER INTERFACE.....	- 54 -
6.2 MONITORING OPERATION.....	- 55 -
CHAPTER 7 FAULT CODE AND TROUBLESHOOTING	- 66 -
CHAPTER 8 RECYCLING AND DISPOSAL	- 70 -
CHAPTER 9 CONTACT SAJ	- 70 -
SAJ WARRANTY POLICY	- 71 -
WARRANTY CARD.....	- 75 -

Chapter 1 Safety Precautions

1.1 Scope of Application

This User Manual describes instructions and detailed procedures for installing, operating, maintaining, and troubleshooting of the following SAJ on-grid inverters:

R5-0.7K-S1; R5-1K-S1; R5-1.5K-S1; R5-2K-S1; R5-2.5K-S1; R5-3K-S1;
R5-3K-S2; R5-3.6K-S2; R5-4K-S2; R5-5K-S2; R5-6K-S2; R5-7K-S2;
R5-8K-S2.

R5-0.7K-S1-15; R5-1K-S1-15; R5-1.5K-S1-15; R5-2K-S1-15; R5-2.5K-S1-15;
R5-3K-S1-15; R5-3K-S2-15; R5-3.6K-S2-15; R5-4K-S2-15; R5-5K-S2-15;
R5-6K-S2-15; R5-7K-S2-15; R5-8K-S2-15.

Please keep this manual all time available in case of emergency.

1.2 Safety Instructions



DANGER

· DANGER indicates a hazardous situation which, if not avoided, will result in death or serious injury.



WARNING

· WARNING indicates a hazardous situation which, if not avoided, can result in death or serious injury or moderate injury.



CAUTION

· CAUTION indicates a hazardous condition which, if not avoided, can result in minor or moderate injury.



NOTICE

· NOTICE indicates a situation that can result in potential damage, if not avoided.

1.3 Target Group

Only qualified electricians who have read and fully understood all safety regulations contained in this manual can install, maintain and repair the inverter. Operators must be aware of the high-voltage device.

Chapter 2 Preparation

2.1 Safety Instructions



DANGER

- There is possibility of dying due to electrical shock and high voltage.
- Do not touch the operating component of the inverter, it might result in burning or death.
- To prevent risk of electric shock during installation and maintenance, please make sure that all AC and DC terminals are plugged out.
- Do not touch the surface of the inverter while the housing is wet, otherwise, this may cause electrical shock.
- Do not stay close to the inverter while there are severe weather conditions including storm, lightning, etc.
- Before opening the housing, the SAJ inverter must be disconnected from the grid and PV generator; you must wait for at least five minutes to let the energy storage capacitors completely discharged after disconnecting from power source.



WARNING

- The installation, service, recycling and disposal of the inverters must be performed by qualified personnel only in compliance with national and local standards and regulations.
- Any unauthorized actions including modification of product functionality of any form may cause lethal hazard to the operator, third parties, the units or their property. SAJ is not responsible for the loss and these warranty claims.
- The SAJ inverter must only be operated with PV generator. Do not connect any other source of energy to the SAJ inverter.
- Be sure that the PV generator and inverter are well grounded in order to protect properties and persons.











**CAUTION**

- The solar inverter will become hot during operation. Please do not touch the heat sink or peripheral surface during or shortly after operation.
- Risk of damage due to improper modifications.

**NOTICE**

- Public utility only.
- The solar inverter is designed to feed AC power directly to the public utility power grid; do not connect AC output of the inverter to any private AC equipment.

2.2 Explanations of Symbols

Symbol	Description
	Dangerous electrical voltage This device is directly connected to public grid, thus all work to the inverter shall only be carried out by qualified personnel.
	Danger to life due to high electrical voltage There might be residual currents in inverter because of large capacitors. Wait for 5 minutes before you remove the front lid.
	Notice, danger! This is directly connected with electricity generators and public grid.
	Danger of hot surface The components inside the inverter will release a lot of heat during operation. Do not touch metal plate housing during operating.
	An error has occurred Please go to Chapter 9 "Troubleshooting" to remedy the error.
	This device shall not be disposed of in residential waste Please go to Chapter 8 "Recycling and Disposal" for proper treatments.
	Without Transformer This inverter does not use transformer for the isolation function.
	CE Mark With CE mark & the inverter fulfills the basic requirements of the Guideline Governing Low-Voltage and Electro-magnetic Compatibility.
	CQC Mark The inverter complies with the safety instructions from China's Quality Center.
 ATTENTION Risk of electric shock! Only authorized operations are allowed to do disassembly, modification or maintenance. Any resulting defect or damage (device/person) is not covered by SAJ warranty.	No unauthorized operations or modifications Any unauthorized operations or modifications are strictly forbidden, if any defect or damage (device/person) occurs, SAJ shall not take any responsibility for it.

Chapter 3 Product Information

3.1 Application Scope of Products

R5-XK-SX products are on-grid single phase inverters without transformers, and the inverters are important components of on-grid solar power systems.

The R5 inverter converts the DC generated by solar panels into AC which is in accordance with the requirements of public grid and send the AC into the grid, Figure 3.1 shows the structural diagram of the typical application system of R5 inverter.

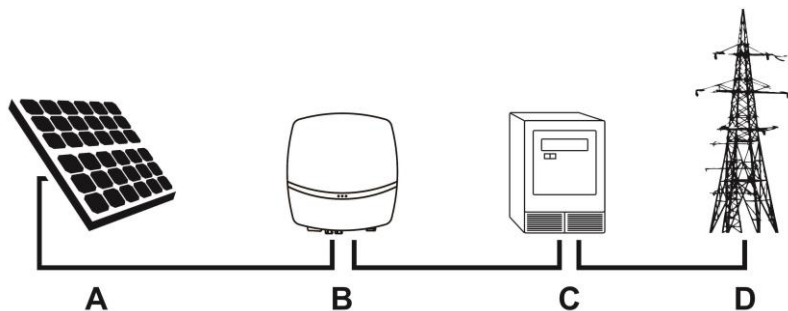

Figure 3.1 R5 series application

Name	Description	Remarks
A	Solar panels	Monocrystalline or polycrystalline silicon, and thin-film PV modules with II protection and need no ground connection
B	Inverters	R5-0.7K/1K/1.5K/2K/2.5K/3K-S1 R5-3K/3.6K/4K/5K/6K/7K/8K-S2 R5-0.7K/1K/1.5K/2K/2.5K/3K-S1-15 R5-3K/3.6K/4K/5K/6K/7K/8K-S2-15
C	Metering equipment	Standard metering tool for measuring the output electric power of inverters.
D	Power grid	TT, TN-C, TN-S, TN-C-S

3.2 Specification for Product Model

R5 – XK – S2–15

① ② ③ ④

- ① R5 represents for product name.
- ② XK represents rated power XkW of inverter, for example 3K means 3kW.
- ③ S means single phase; 1 or 2 represents that the inverter has the function of one or double MPPT.
- ④ 15 means the string current is 15A

3.3 Overview of Products

The dimensions of R5 series products are shown below.

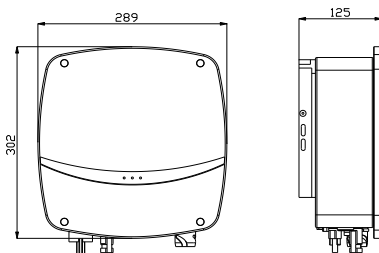

Figure 3.2 Dimensions of R5-0.7K/1K/1.5K/2K/2.5K/3K-S1

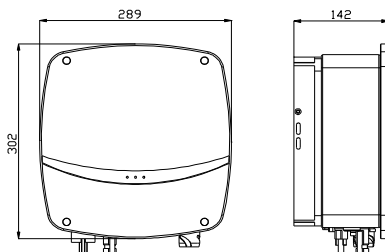

Figure 3.3 Dimensions of R5-0.7K/1K/1.5K/2K/2.5K/3K-S1-15

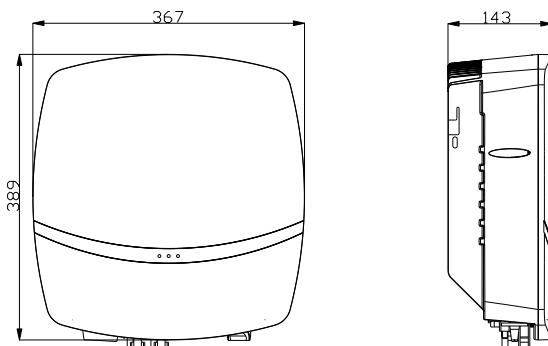

Figure 3.4 Dimensions of R5-3K/3.6K/4K/5K/6K-S2
R5-3K/3.6K/4K/5K/6K-S2-15

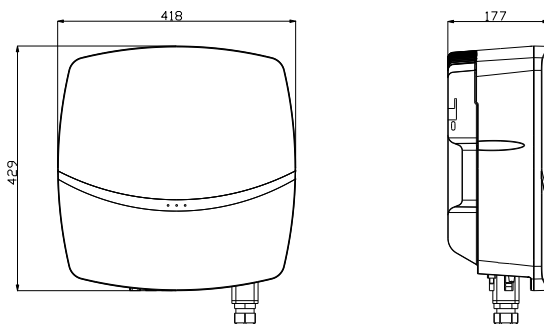

Figure 3.5 Dimensions of R5-7K/8K-S2
R5-7K/8K-S2-15

3.4 Datasheet

R5-0.7K/1K/1.5K-S1

Type	R5-0.7K-S1	R5-1K-S1	R5-1.5K-S1
Input (DC)			
Max. PV Array Power [Wp]@STC	1050	1500	2250
Max. DC Voltage [V]	450		
MPPT Voltage Range [V]	40-425		
Nominal DC Voltage [V]	360		
Start Voltage [V]	40		
Min. DC Voltage [V]	40		
Max. DC Input Current [A]	12.5		
Max. DC Short Current [A]	15		
Number of DC Connection Sets per MPPT	1		
Number of MPPT	1		
DC Switch	Integrated		
Output (AC)			
Rated AC Power [W]	700	1000	1500
Rated Apparent Power [VA] ¹	770	1100	1650
Rated AC Current [A]@230Vac	3.1	4.4	6.6
Max. AC Current [A]	3.5	5	7.5
Nominal AC Voltage/Range [V]	220,230,240/180-280		
Grid Frequency/ Range [Hz]	50,60/45-55,55-65		
Power Factor [cos φ]	0.8 leading~0.8 lagging		
Total Harmonic Distortion [THDi]	< 2%		
Feed-in	L+N+PE		
Efficiency			
Max. Efficiency	97.20%	97.30%	97.40%
Euro Efficiency	96.40%	96.70%	96.80%
MPPT Accuracy	>99.5%		
Protection			
Internal Over-voltage Protection	Integrated		
DC Insulation Monitoring	Integrated		

DCI Monitoring	Integrated
GFCI Monitoring	Integrated
Grid Monitoring	Integrated
AC Short Circuit Current Protection	Integrated
AC grounding detection	Integrated
DC Surge Protection	Integrated
AC Surge Protection	Integrated
Thermal Protection	Integrated
Anti-island protection monitoring	AFD
Interface	
AC Connection	Plug-in connector
DC Connection	MC4
Human Machine Interface	LED+(Bluetooth/Wi-Fi+APP)
Communication Port	RS232(USB)+RS485(RJ45)
Communication Mode	Wi-Fi/GPRS/4G(Optional)
General Data	
Topology	Transformerless
Consumption at Night [W]	<0.2
Consumption at Standby [W]	6
Operating Temperature Range	-40°C~+60°C[45°C to 60°C with derating]
Cooling Method	Natural Convection
Ambient Humidity	0%~100% Non-condensing
Altitude	4000m(>3000m power derating)
Noise [dBA]	<25
Ingress Protection	IP65
Mounting	Rear Panel
Dimensions[H*W*D] [mm]	302*289*125
Weight [kg]	5.2
Standard Warranty [Year]	5(standard)/10/15/20/25(Optional)
Applicable Standard	CQC NB/T 32004,EN62109-1/2,EN61000-6-1/2/3/4, EN50438,EN50549-1,C10/C11,IEC62116,IEC61727,RD 1699, G98,G99,UNE206006,UNE206007-1,CEI0-21,AS/NZS4 777.2

R5-2K/2.5K/3K-S1

Type	R5-2K-S1	R5-2.5K-S1	R5-3K-S1
Input (DC)			
Max. PV Array Power [Wp]@STC	3000	3750	4500
0Max. DC Voltage [V]	500		
MPPT Voltage Range [V]	50-450		
Nominal DC Voltage [V]	360		
Start Voltage [V]	50		
Min. DC Voltage [V]	40		
Max. DC Input Current [A]	12.5		
Max. DC Short Current [A]	15		
Number of DC Connection Sets per MPPT	1		
Number of MPPT	1		
DC Switch	Integrated		
Output (AC)			
Rated AC Power [W]	2000	2500	3000
Rated Apparent Power [VA] ¹	2200	2750	3300
Rated AC Current [A]@230Vac	8.7	10.9	13.1
Max. AC Current [A]	10	12.5	15
Nominal AC Voltage/Range [V]	220,230,240/180-280		
Grid Frequency/ Range [Hz]	50,60/45-55,55-65		
Power Factor [cos φ]	0.8 leading~0.8 lagging		
Total Harmonic Distortion [THDi]	< 2%		
Feed-in	L+N+PE		
Efficiency			
Max. Efficiency	97.60%	97.70%	97.80%
Euro Efficiency	97.00%	97.10%	97.20%
MPPT Accuracy	>99.5%		
Protection			
Internal Over-voltage Protection	Integrated		
DC Insulation Monitoring	Integrated		
DCI Monitoring	Integrated		
GFCI Monitoring	Integrated		

Grid Monitoring	Integrated
AC Short Circuit Current Protection	Integrated
AC grounding detection	Integrated
DC Surge Protection	Integrated
AC Surge Protection	Integrated
Thermal Protection	Integrated
Anti-island protection monitoring	AFD
Interface	
AC Connection	Plug-in connector
DC Connection	MC4
Human Machine Interface	LED+(Bluetooth/Wi-Fi+APP)
Communication Port	RS232(USB)+RS485(RJ45)
Communication Mode	Wi-Fi/GPRS/4G(Optional)
General Data	
Topology	Transformerless
Consumption at Night [W]	<0.2
Consumption at Standby [W]	6
Operating Temperature Range	-40°C~+60°C[45°C to 60°C with derating]
Cooling Method	Natural Convection
Ambient Humidity	0%~100% Non-condensing
Altitude	4000m(>3000m power derating)
Noise [dBA]	<25
Ingress Protection	IP65
Mounting	Rear Panel
Dimensions[H*W*D] [mm]	302*289*125
Weight [kg]	5.5
Standard Warranty [Year]	5(standard)/10/15/20/25(Optional)
Applicable Standard	CQC NB/T 32004,EN62109-1/2,EN61000-6-1/2/3/4, EN50438,EN50549-1,C10/C11,IEC62116,IEC61727,RD 1699, G98,G99,UNE206006,UNE206007-1,CEI0-21,AS/NZS4 777.2

R5-3K/3.6K/4K/5K/6K-S2

Type	R5-3K-S2	R5-3.6K-S ₂	R5-4K-S2	R5-5K-S2	R5-6K-S2
Input (DC)					
Max. PV Array Power [Wp]@STC	4500	5520	6000	7500	9000
Max. DC Voltage [V]	600				
MPPT Voltage Range [V]	90-550				
Nominal DC Voltage [V]	360				
Start Voltage [V]	100				
Min. DC Voltage [V]	80				
Max. DC Input Current [A]	12.5/12.5				
Max. DC Short Current [A]	15/15				
Number of DC Connection Sets per MPPT	1/1				
Number of MPPT	2				
DC Switch	Integrated				
Output (AC)					
Rated AC Power [W]	3000	3680	4000	4600 ² / 5000 ³ / 5000	6000
Rated Apparent Power [VA] ¹	3300	3680	4400	4600 ² / 5000 ³ / 5500	6000
Rated AC Current [A]@230Vac	13.1	16	17.4	20/21.8/ 21.8	26.1
Max. AC Current [A]	14.4	16	19.2	20/21.8/ 23.9	26.1
Nominal AC Voltage/Range [V]	220,230,240/180-280				
Grid Frequency/ Range [Hz]	50,60/45-55,55-65				
Power Factor [cos φ]	0.8 leading-0.8 lagging				
Total Harmonic Distortion [THDi]	< 2%				
Feed-in	L+N+PE				
Efficiency					
Max. Efficiency	97.8%	98.0%	98.0%	98.1%	98.2%
Euro Efficiency	97.2%	97.5%	97.5%	97.6%	97.6%
MPPT Accuracy	>99.5%				

Protection	
Internal Over-voltage Protection	Integrated
DC Insulation Monitoring	Integrated
DCI Monitoring	Integrated
GFCI Monitoring	Integrated
Grid Monitoring	Integrated
AC Short Circuit Current Protection	Integrated
AC grounding detection	Integrated
DC Surge Protection	Integrated
AC Surge Protection	Integrated
Thermal Protection	Integrated
Anti-island protection monitoring	AFD
Interface	
AC Connection	Plug-in connector
DC Connection	MC4
Human Machine Interface	LED+(Bluetooth/Wi-Fi+APP)
Communication Port	RS232(USB)+RS485(RJ45)
Communication Mode	Wi-Fi/GPRS/4G(Optional)
General Data	
Topology	Transformerless
Consumption at Night [W]	<0.2
Consumption at Standby [W]	6
Operating Temperature Range	-40°C~+60°C[45°C to 60°C with derating]
Cooling Method	Natural Convection
Ambient Humidity	0%~100% Non-condensing
Altitude	4000m(>3000m power derating)
Noise [dBA]	<25
Ingress Protection	IP65
Mounting	Rear Panel
Dimensions[H*W*D] [mm]	389*367*143
Weight [kg]	12.2
Standard Warranty [Year]	5(standard)/10/15/20/25(Optional)
Applicable Standard	CQC NB/T 32004,EN62109-1/2,EN61000-6-1/2/3/4, EN50438,EN50549-1,C10/C11,IEC62116,IEC61727,RD

	1699,
--	-------

	G98,G99,UNE206006,UNE206007-1,CEI0-21,AS/NZS4 777.2
--	--

R5-7K/8K-S2

Type	R5-7K-S2	R5-8K-S2
Input (DC)		
Max. PV Array Power [Wp]@STC	10500	12000
Max. DC Voltage [V]	600	
MPPT Voltage Range [V]	90-550	
Nominal DC Voltage[V]	360	
Start Voltage [V]	100	
Min. DC Voltage [V]	80	
Max. DC Input Current [A]	25/12.5	
Max. DC Short Current [A]	30/15	
Number of DC Connection Sets per MPPT	2/1	
Number of MPPT	2	
DC Switch	Integrated	
Output (AC)		
Rated AC Power [W]	7000	8000
Rated Apparent Power [VA] ¹	7700	8000
Rated AC Current [A]@230Vac	30.5	34.8
Max. AC Current [A]	33.5	34.8
Nominal AC Voltage/ Range [V]	220,230,240/180-280	
Grid Frequency/ Range [Hz]	50, 60/45-55, 55-65	
Power Factor [cos φ]	0.8 leading~0.8 lagging	
Total Harmonic Distortion [THDi]	< 2%	
Feed-in	L+N+PE	
Efficiency		
Max. Efficiency	98.2%	98.3%
Euro Efficiency	97.7%	97.8%
MPPT Accuracy	>99.5%	
Protection		
Internal Over-voltage Protection	Integrated	
DC Insulation Monitoring	Integrated	
DCI Monitoring	Integrated	
GFCI Monitoring	Integrated	

Grid Monitoring	Integrated
AC Short Circuit Current Protection	Integrated
AC grounding detection	Integrated
DC Surge Protection	Integrated
AC Surge Protection	Integrated
Thermal Protection	Integrated
Anti-island Protection Monitoring	AFD
Interface	
AC Connection	Terminal Block
DC Connection	MC4
Human Machine Interface	LED+(Bluetooth/Wi-Fi+APP)
Communication Port	RS232(USB)+RS485(RJ45)
Communication Mode	Wi-Fi/GPRS/4G(Optional)
General Data	
Topology	Transformerless
Consumption at Night [W]	<0.2
Consumption at Standby [W]	6
Operating Temperature Range	-40°C~+60°C[45°C to 60°C with derating]
Cooling Method	Natural Convection
Ambient Humidity	0-100% Non-condensing
Altitude	4000m(>3000m power derating)
Noise [dBA]	<25
Ingress Protection	IP65
Mounting	Rear Panel
Dimensions [H*W*D][mm]	429*418*177
Weight [kg]	18
Standard Warranty [Year]	5(standard)/10/15/20/25(Optional)
Applicable Standard	CQC NB/T 32004, EN62109-1/2, EN61000-6-1/2/3/4, EN50438, EN50549-1, IEC62116, IEC61727, RD1699, UNE206006, UNE206007-1, CEI0-21,G99

R5-0.7K/1K/1.5K-S1-15

Type	R5-0.7K-S1-15	R5-1K-S1-15	R5-1.5K-S1-15
Input (DC)			
Max. PV Array Power [Wp]@STC	1050	1500	2250
Max. DC Voltage [V]	450		
MPPT Voltage Range [V]	40-425		
Nominal DC Voltage [V]	360		
Start Voltage [V]	40		
Min. DC Voltage [V]	40		
Max. DC Input Current [A]	15		
Max. DC Short Current [A]	18		
Number of DC Connection Sets per MPPT	1		
Number of MPPT	1		
DC Switch	Integrated		
Output (AC)			
Rated AC Power [W]	700	1000	1500
Rated Apparent Power [VA] ¹	770	1100	1650
Rated AC Current [A]@230Vac	3.1	4.4	6.6
Max. AC Current [A]	3.5	5	7.5
Nominal AC Voltage/Range [V]	220,230,240/180-280		
Grid Frequency/ Range [Hz]	50,60/45-55,55-65		
Power Factor [cos φ]	0.8 leading~0.8 lagging		
Total Harmonic Distortion [THDi]	< 2%		
Feed-in	L+N+PE		
Efficiency			
Max. Efficiency	97.20%	97.30%	97.40%
Euro Efficiency	96.40%	96.70%	96.80%
MPPT Accuracy	>99.5%		
Protection			
Internal Over-voltage Protection	Integrated		
DC Insulation Monitoring	Integrated		
DCI Monitoring	Integrated		
GFCI Monitoring	Integrated		

Grid Monitoring	Integrated
AC Short Circuit Current Protection	Integrated
AC grounding detection	Integrated
DC Surge Protection	Integrated
AC Surge Protection	Integrated
Thermal Protection	Integrated
Anti-island protection monitoring	AFD
Interface	
AC Connection	Plug-in connector
DC Connection	MC4
Human Machine Interface	LED+(Bluetooth/Wi-Fi+APP)
Communication Port	RS232(USB)+RS485(RJ45)
Communication Mode	Wi-Fi/GPRS/4G(Optional)
General Data	
Topology	Transformerless
Consumption at Night [W]	<0.2
Consumption at Standby [W]	6
Operating Temperature Range	-40°C~+60°C[45°C to 60°C with derating]
Cooling Method	Natural Convection
Ambient Humidity	0%~100% Non-condensing
Altitude	4000m(>3000m power derating)
Noise [dBA]	<25
Ingress Protection	IP65
Mounting	Rear Panel
Dimensions[H*W*D] [mm]	302*289*142
Weight [kg]	7.2
Standard Warranty [Year]	5(standard)/10/15/20/25(Optional)
Applicable Standard	CQC NB/T 32004,EN62109-1/2,EN61000-6-1/2/3/4, EN50438,EN50549-1,C10/C11,IEC62116,IEC61727,RD 1699, G98,G99,UNE206006,UNE206007-1,CEI0-21,AS/NZS4 777.2

R5-2K/2.5K/3K-S1-15

Type	R5-2K-S1-15	R5-2.5K-S1-15	R5-3K-S1-15
Input (DC)			
Max. PV Array Power [Wp]@STC	3000	3750	4500
0Max. DC Voltage [V]	500		
MPPT Voltage Range [V]	50-450		
Nominal DC Voltage [V]	360		
Start Voltage [V]	50		
Min. DC Voltage [V]	40		
Max. DC Input Current [A]	15		
Max. DC Short Current [A]	18		
Number of DC Connection Sets per MPPT	1		
Number of MPPT	1		
DC Switch	Integrated		
Output (AC)			
Rated AC Power [W]	2000	2500	3000
Rated Apparent Power [VA] ¹	2200	2750	3300
Rated AC Current [A]@230Vac	8.7	10.9	13.1
Max. AC Current [A]	10	12.5	15
Nominal AC Voltage/Range [V]	220,230,240/180-280		
Grid Frequency/ Range [Hz]	50,60/45-55,55-65		
Power Factor [cos φ]	0.8 leading~0.8 lagging		
Total Harmonic Distortion [THDi]	< 2%		
Feed-in	L+N+PE		
Efficiency			
Max. Efficiency	97.60%	97.70%	97.80%
Euro Efficiency	97.00%	97.10%	97.20%
MPPT Accuracy	>99.5%		
Protection			
Internal Over-voltage Protection	Integrated		
DC Insulation Monitoring	Integrated		
DCI Monitoring	Integrated		
GFCI Monitoring	Integrated		

Grid Monitoring	Integrated
AC Short Circuit Current Protection	Integrated
AC grounding detection	Integrated
DC Surge Protection	Integrated
AC Surge Protection	Integrated
Thermal Protection	Integrated
Anti-island protection monitoring	AFD
Interface	
AC Connection	Plug-in connector
DC Connection	MC4
Human Machine Interface	LED+(Bluetooth/Wi-Fi+APP)
Communication Port	RS232(USB)+RS485(RJ45)
Communication Mode	Wi-Fi/GPRS/4G(Optional)
General Data	
Topology	Transformerless
Consumption at Night [W]	<0.2
Consumption at Standby [W]	6
Operating Temperature Range	-40°C~+60°C[45°C to 60°C with derating]
Cooling Method	Natural Convection
Ambient Humidity	0%~100% Non-condensing
Altitude	4000m(>3000m power derating)
Noise [dBA]	<25
Ingress Protection	IP65
Mounting	Rear Panel
Dimensions[H*W*D] [mm]	302*289*142
Weight [kg]	7.5
Standard Warranty [Year]	5(standard)/10/15/20/25(Optional)
Applicable Standard	CQC NB/T 32004,EN62109-1/2,EN61000-6-1/2/3/4, EN50438,EN50549-1,C10/C11,IEC62116,IEC61727,RD 1699, G98,G99,UNE206006,UNE206007-1,CEI0-21,AS/NZS4 777.2

R5-3K/3.6K/4K/5K/6K-S2-15

Type	R5-3K-S2-1 5	R5-3.6K-S2-15	R5-4K-S2-15	R5-5K-S2-15	R5-6K-S2-15
Input (DC)					
Max. PV Array Power [Wp]@STC	4500	5520	6000	7500	9000
Max. DC Voltage [V]	600				
MPPT Voltage Range [V]	90-550				
Nominal DC Voltage [V]	360				
Start Voltage [V]	100				
Min. DC Voltage [V]	80				
Max. DC Input Current [A]	15/15				
Max. DC Short Current [A]	18/18				
Number of DC Connection Sets per MPPT	1/1				
Number of MPPT	2				
DC Switch	Integrated				
Output (AC)					
Rated AC Power [W]	3000	3680	4000	4600 ² / 5000 ³ / 5000	6000
Rated Apparent Power [VA] ¹	3300	3680	4400	4600 ² / 5000 ³ / 5500	6000
Rated AC Current [A]@230Vac	13.1	16	17.4	20/21.8/ 21.8	26.1
Max. AC Current [A]	14.4	16	19.2	20/21.8/ 23.9	26.1
Nominal AC Voltage/Range [V]	220,230,240/180-280				
Grid Frequency/ Range [Hz]	50,60/45-55,55-65				
Power Factor [cos φ]	0.8 leading-0.8 lagging				
Total Harmonic Distortion [THDi]	< 2%				
Feed-in	L+N+PE				
Efficiency					
Max. Efficiency	97.8%	98.0%	98.0%	98.1%	98.2%
Euro Efficiency	97.2%	97.5%	97.5%	97.6%	97.6%

MPPT Accuracy	>99.5%
Protection	
Internal Over-voltage Protection	Integrated
DC Insulation Monitoring	Integrated
DCI Monitoring	Integrated
GFCI Monitoring	Integrated
Grid Monitoring	Integrated
AC Short Circuit Current Protection	Integrated
AC grounding detection	Integrated
DC Surge Protection	Integrated
AC Surge Protection	Integrated
Thermal Protection	Integrated
Anti-island protection monitoring	AFD
Interface	
AC Connection	Plug-in connector
DC Connection	MC4
Human Machine Interface	LED+(Bluetooth/Wi-Fi+APP)
Communication Port	RS232(USB)+RS485(RJ45)
Communication Mode	Wi-Fi/GPRS/4G(Optional)
General Data	
Topology	Transformerless
Consumption at Night [W]	<0.2
Consumption at Standby [W]	6
Operating Temperature Range	-40°C~+60°C[45°C to 60°C with derating]
Cooling Method	Natural Convection
Ambient Humidity	0%~100% Non-condensing
Altitude	4000m(>3000m power derating)
Noise [dBA]	<25
Ingress Protection	IP65
Mounting	Rear Panel
Dimensions[H*W*D] [mm]	389*367*143
Weight [kg]	12.2
Standard Warranty [Year]	5(standard)/10/15/20/25(Optional)

Applicable Standard	CQC NB/T 32004,EN62109-1/2,EN61000-6-1/2/3/4, EN50438,EN50549-1,C10/C11,IEC62116,IEC61727,RD1 699, G98,G99,UNE206006,UNE206007-1,CEI0-21,AS/NZS477 7.2
---------------------	--

R5-7K/8K-S2-15

Type	R5-7K-S2-15	R5-8K-S2-15
Input (DC)		
Max. PV Array Power [Wp]@STC	10500	12000
Max. DC Voltage [V]	600	
MPPT Voltage Range [V]	90-550	
Nominal DC Voltage[V]	360	
Start Voltage [V]	100	
Min. DC Voltage [V]	80	
Max. DC Input Current [A]	30/15	
Max. DC Short Current [A]	36/18	
Number of DC Connection Sets per MPPT	2/1	
Number of MPPT	2	
DC Switch	Integrated	
Output (AC)		
Rated AC Power [W]	7000	8000
Rated Apparent Power [VA] ¹	7700	8000
Rated AC Current [A]@230Vac	30.5	34.8
Max. AC Current [A]	33.5	34.8
Nominal AC Voltage/ Range [V]	220,230,240/180-280	
Grid Frequency/ Range [Hz]	50, 60/45-55, 55-65	
Power Factor [cos φ]	0.8 leading~0.8 lagging	
Total Harmonic Distortion [THDi]	< 2%	
Feed-in	L+N+PE	
Efficiency		
Max. Efficiency	98.2%	98.3%
Euro Efficiency	97.7%	97.8%
MPPT Accuracy	>99.5%	
Protection		
Internal Over-voltage Protection	Integrated	
DC Insulation Monitoring	Integrated	
DCI Monitoring	Integrated	
GFCI Monitoring	Integrated	

Grid Monitoring	Integrated
AC Short Circuit Current Protection	Integrated
AC grounding detection	Integrated
DC Surge Protection	Integrated
AC Surge Protection	Integrated
Thermal Protection	Integrated
Anti-island Protection Monitoring	AFD
Interface	
AC Connection	Terminal Block
DC Connection	MC4
Human Machine Interface	LED+(Bluetooth/Wi-Fi+APP)
Communication Port	RS232(USB)+RS485(RJ45)
Communication Mode	Wi-Fi/GPRS/4G(Optional)
General Data	
Topology	Transformerless
Consumption at Night [W]	<0.2
Consumption at Standby [W]	6
Operating Temperature Range	-40°C~+60°C[45°C to 60°C with derating]
Cooling Method	Natural Convection
Ambient Humidity	0-100% Non-condensing
Altitude	4000m(>3000m power derating)
Noise [dBA]	<25
Ingress Protection	IP65
Mounting	Rear Panel
Dimensions [H*W*D][mm]	429*418*177
Weight [kg]	18
Standard Warranty [Year]	5(standard)/10/15/20/25(Optional)
Applicable Standard	CQC NB/T 32004, EN62109-1/2, EN61000-6-1/2/3/4, EN50438, EN50549-1, IEC62116, IEC61727, RD1699, UNE206006, UNE206007-1, CEI0-21,G99

Note:

1. According to C10/C11, Max. AC Power = Rated AC Power
2. Meet the VDE - ARN - N 4105 that biggest apparent power of single-phase is 4600 VA.
3. Applicable to Belgian grid standard.

Chapter 4 Instructions for Installation

4.1 Safety Instructions



DANGER

- Dangerous to life due to potential fire or electricity shock.
- Do not install the inverter near any inflammable or explosive items.
- This inverter will be directly connected with HIGH VOLTAGE power generation device; the installation must be performed by qualified personnel only in compliance with national and local standards and regulations.



NOTICE

- This equipment meets the pollution degree II.
- Inappropriate installation environment may jeopardize the life span of the inverter.
- Installation directly exposed under intensive sunlight is not recommended.
- The installation site must be well ventilated.

4.2 Pre-installation Check

4.2.1 Check the Package

Although SAJ's inverters have surpassed stringent testing and are checked before leaving factory, it is still possible that the inverters may suffer damages during transportation. Please check the package for any obvious signs of damage, and if such evidence is present, do not open the package and contact your dealer as soon as possible.

4.2.2 Check the Assembly Parts

Please refer to the packing list inside the package container.

4.3 The Determination of the Installation Method and Position

4.3.1 Mounting Method

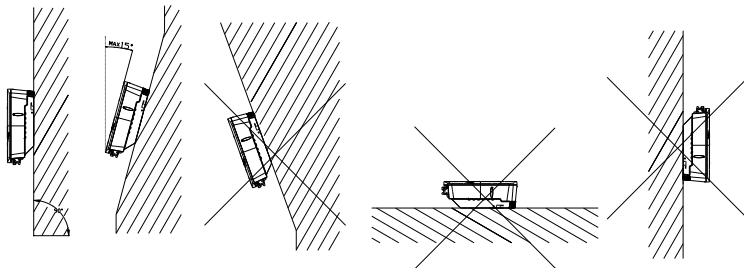

Figure 4.1 Mounting method

- ① The equipment employs natural convection cooling method, and it can be installed indoor or outdoor.
- ② Please install the equipment under the guidance of Figure 4.1. Vertical installation on floor level is recommended. Mount vertically or tilted backwards by max. 15°. Never install the inverter tilted forwards, sideways, horizontally or upside down.
- ③ Considering convenience for maintenance, please install the equipment at a position in parallel with line of sight.
- ④ When mounting the inverter, please consider the solidity of wall for inverter, including accessories. Please ensure the Rear Panel mount tightly.

Before installation, make sure that the wall has enough strength to hold the screws and bear the weight of the equipment. Please make sure the equipment is installed properly.

4.3.2 Installation Position

Do not expose the inverter to direct solar irradiation as this could cause power derating due to overheating. The ambient temperature should be between $-40^{\circ}\text{C} \sim +60^{\circ}\text{C}$ ($-40^{\circ}\text{F} \sim 140^{\circ}\text{F}$) to ensure optimum operation.

Choose locations with sufficient air exchange. Ensure additional ventilation, if necessary.

To make sure the installation spot is suitably ventilated, if multiple SAJ on-grid solar inverters are installed together, the following safety clearance in Figure 4.2 shall be followed for proper ventilation conditions.

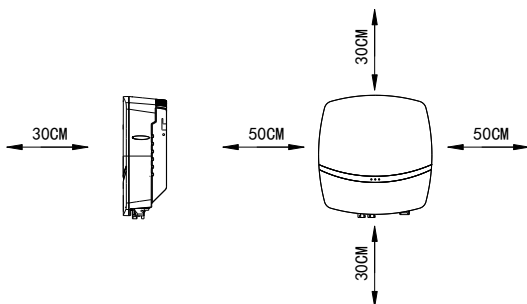

4.2 Installation position

4.4 Mounting Procedure

4.4.1 Mark the Positions of the Drill Holes of the Rear Panel

The mounting position should be marked as shown in Figure 4.3, Figure 4.4, Figure 4.5.

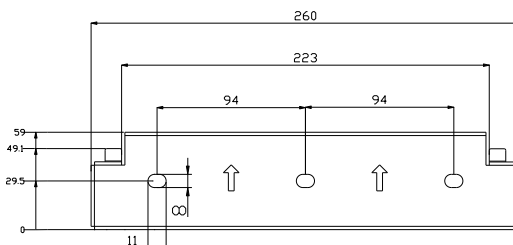

Figure 4.3 Dimensions of rear panel of R5-0.7K/1K/1.5K/2K/2.5K/3K-S1

R5-0.7K/1K/1.5K/2K/2.5K/3K-S1-15

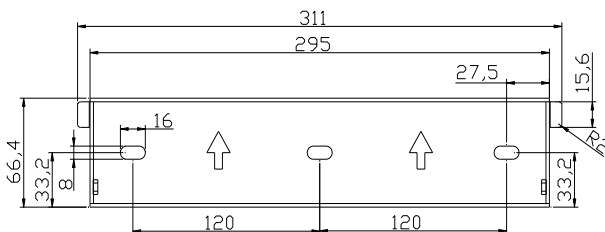

Figure 4.4 Dimensions of rear panel of R5-3K/3.6K/4K/5K/6K-S2,
R5-3K/3.6K/4K/5K/6K-S2-15

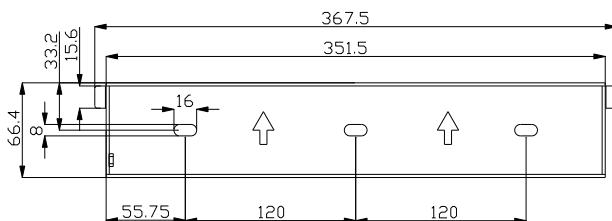

Figure 4.5 Dimensions of rear panel of R5-7K/8K-S2,
R5-7K/8K-S2-15

4.4.2 Drill Holes and Place the Expansion Tubes

Follow the given guides, drill 3 holes in the wall (in conformity with position marked in Figure 4.6&Figure 4.7), and then place expansion tubes in the holes using a rubber mallet.

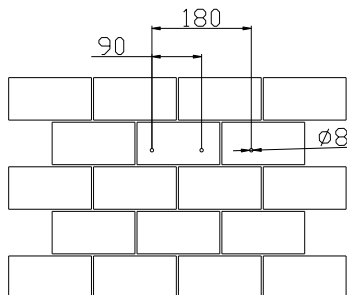

Figure 4.6 Drill holes' dimensions of R5-0.7K/1K/1.5K/2K/2.5K/3K-S1
R5-0.7K/1K/1.5K/2K/2.5K/3K-S1-15

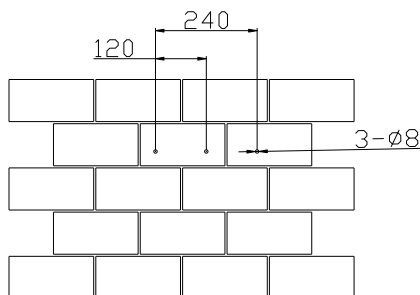

Figure 4.7 Drill holes' dimensions of R5-3K/3.6K/4K/5K/6K/7K/8K-S2,

R5-3K/3.6K/4K/5K/6K/7K/8K-S2-15

4.4.3 Mount the Screws and the Rear Panel

The panels should be mounted in the mounting position by screws as shown in Figure 4.8.

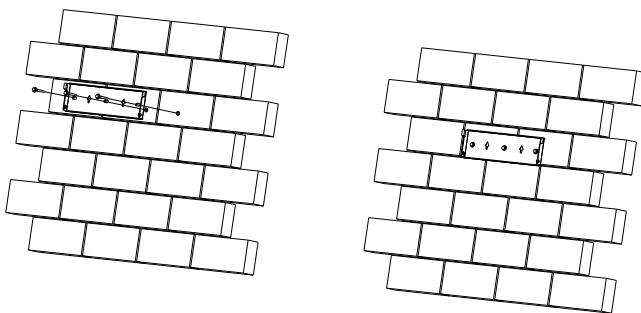

Figure 4.8 Mount the rear panel of R5-0.7K-3K-S1/ R5-0.7K-3K-S1-15

R5-3K-8K-S2-15

4.4.4 Mount the Inverter

Carefully mount the inverter to the rear panel as shown in Figure 4.9 and 4.10, Make sure that the rear part of the equipment is closely mounted to the rear panel.

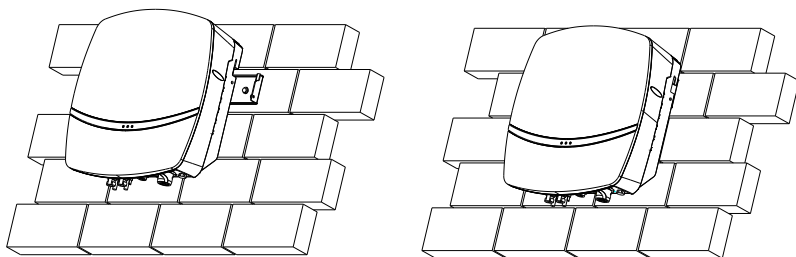

Figure 4.9 Mount R5-0.7K-3K-S1/R5-0.7K-3K-S1-15

R5-3K-8K-S2 -15 inverter

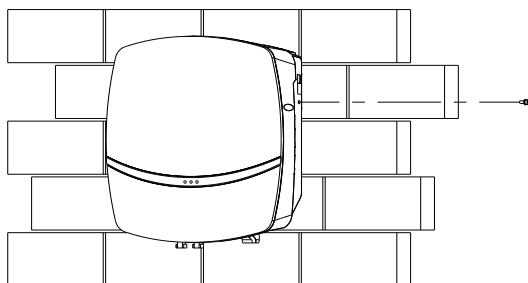

Fig. 4.10 Fasten the inverter and hanging panel with screws

4.4.5 Install Anti-theft Lock

As shown in figure 4.11, anti-theft lock could be added to the inverter and hanging panel. Diameter of the lock hole is $\phi 6.0\text{mm}$ and anti-theft lock with a $\phi 5.0\text{mm}$ diameter of lock hook is recommended.

Users should prepare anti-theft lock by themselves.

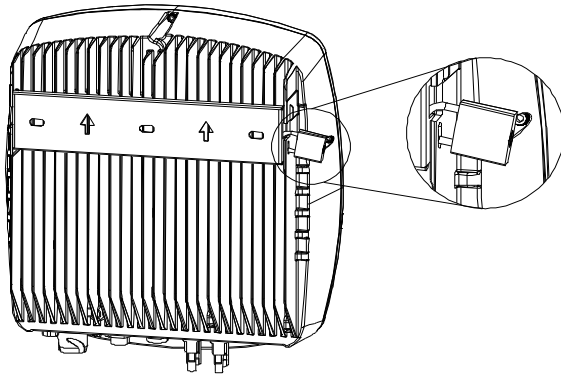

Figure 4.11 Install anti-theft lock

Chapter 5 Electrical Connection

5.1 Safety Instruction for Hot-line Job

Electrical connection must only be operated by professional technicians. Please keep in mind that the inverter is a bi-power supply equipment. Before connection, necessary protective equipment must be employed by technicians, including insulating gloves, insulating shoes and safety helmet.



DANGER

- Dangerous to life due to potential fire or electricity shock.
- When power-on, the equipment should be in conformity with national rules and regulations.
- The direct connection between the inverter and high voltage power systems must be operated by qualified technicians in accordance with local and national power grid standards and regulations.



WARNING

- When the PV array is exposed to light, it supplies a DC voltage to the inverter.



NOTICE

- Electrical connection should be in conformity with proper stipulations, such as stipulations for cross-sectional area of conductors, fuse and ground protection.
- The overvoltage category on DC input port is II, on AC output port is III.

5.2 Specifications for Electrical Interface

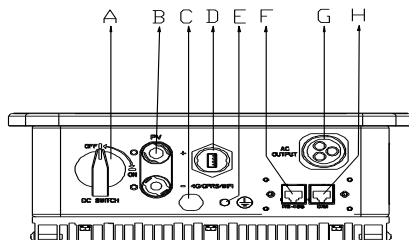

Figure 5.1 Electrical interface of R5-0.7K/1K/1.5K/2K/2.5K/3K-S1

Code	Name
A	DC Switch
B	DC Input
C	Decompression Valves
D	RS232 Communication(GPRS/Wi-Fi/4G)
E	Ground Connection
F	RS485 Communication
G	AC Output
H	DRM (Optional)

Table 5.1 Specifications for interface

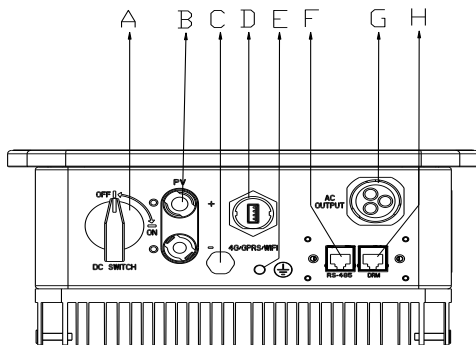

Figure 5.2 Electrical interface of R5-0.7K/1K/1.5K/2K/2.5K/3K-S1-15

Code	Name
A	DC Switch
B	DC Input
C	Decompression Valves
D	RS232 Communication(GPRS/Wi-Fi/4G)
E	Ground Connection
F	RS485 Communication
G	AC Output
H	DRM (Optional)

Table 5.2 Specifications for interface

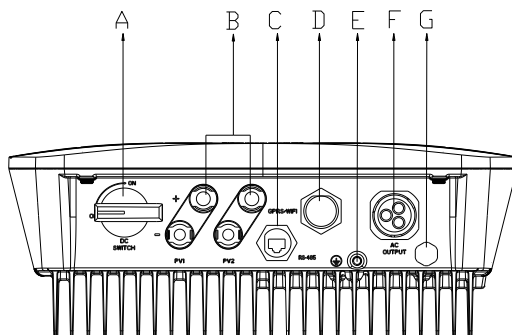

Figure 5.3 Electrical interface of R5-3K/3.6K/4K/5K/6K-S2

R5-3K/3.6K/4K/5K/6K-S2-15

Code	Name
A	DC Switch
B	DC Input
C	RS485 Communication
D	RS232 Communication(GPRS/Wi-Fi/4G)
E	Ground Connection
F	AC Output
G	Decompression Valves

Table 5.3 Specifications for interface

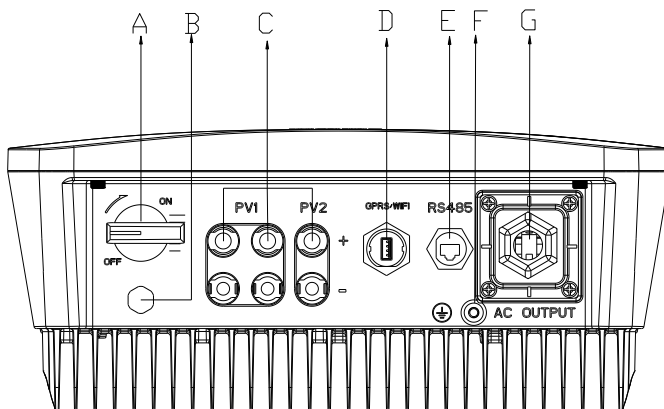

Figure 5.4 Electrical interface of R5-7K/8K-S2

R5-7K/8K-S2-15

Code	Name
A	DC Switch
B	Decompression Valves
C	DC Input
D	RS232 Communication(GPRS/Wi-Fi/4G)
E	RS485 Communication
F	Ground Connection
G	AC Output

Table 5.4 Specifications for interface

5.3 AC Connection

Type	Wire cross sectional area recommended value/max. value (mm ²)	External diameter (mm)
R5-0.7K/1K/1.K/2K/2.5K/3K-S1 R5-0.7K/1K/1.K/2K/2.5K/3K-S1-1 5	4.0 /6.0	4.2~5.3
R5-3K/3.6K/4K/5K/6K-S2 R5-3K/3.6K/4K/5K/6K-S2-15	4.0 /6.0	4.2~5.3
R5-7K/8K-S2 & R5-7K/8K-S2-15	3*8.37/3*10	15~22

Table 5.5 Recommended power grid connecting cable specification

If the grid-connection distance is too far, please select an AC cable with larger diameter as per the actual condition.

5.3.1 GND of the Inverter.

After penetrating the external hex head screw through OT terminal of the grounding line, screw in the grounding port of inverter enclosure in clockwise direction and make sure it is screwed up tightly.

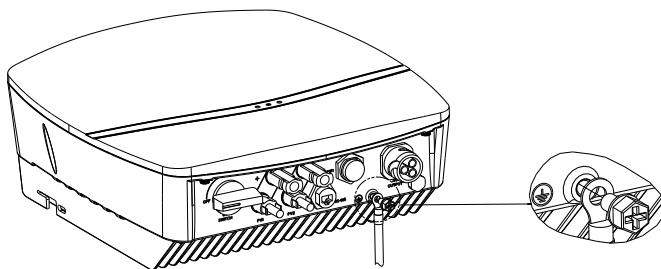

Fig. 5.5 Inverter ground protection

5.3.2 R5-0.7K-3K-S1/R5-0.7K-3K-S1-15 AC Side Electrical Connection

- ① Feed the AC cable through the AC waterproof hole.

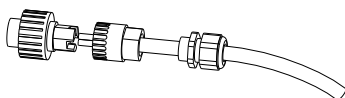

Figure 5.6 Feed cable

- ② Connect the cables according to connection marks of L, N and PE.

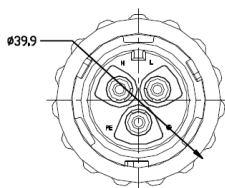

Figure 5.7 Connect cable

- ③ Screw all parts of the AC connector.

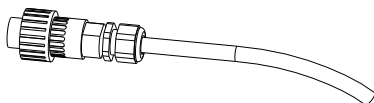

Figure 5.8 Screw the connector

- ④ Connect the AC connector to the equipment securely, ensuring the pins are connected directly. Then the connection of AC cable is completed.

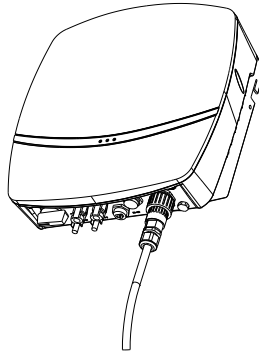

Figure 5.9 Connect the inverter

5.3.3 R5-7K/8K-S2 & R5-7K/8K-S2-15 AC Side Electrical Connection

① Screw off the screws at the AC output wire cover and take out the cover. Penetrate the AC cable of which the insulation layers has been peeled off through the AC waterproof locking screw hole of the cover. Lock L, N and PE tightly as per the marked connection positions on the interface board.

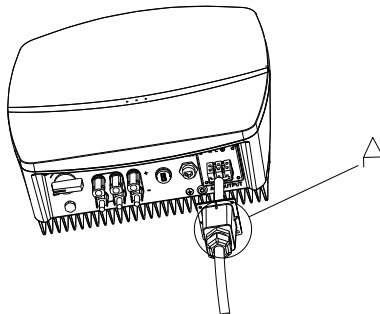

Fig. 5.10 Connecting the cable

② After fixing the cover at the AC output wire terminal with screws, tighten up the AC waterproof nut.

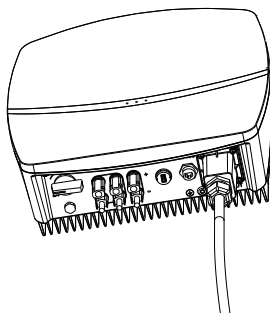

Fig. 5.11 Tighten up AC interface protective cover and the locker

5.3.4 Earth Fault Alarm

This inverter complies with IEC 62109-2 clause 13.9 for earth fault alarm monitoring. If an Earth Fault Alarm occurs, all the LED indicators will be lit up in red and error code <31 Insulation Error Master> will be displayed on the screen of inverter Wi-Fi communication module until the error being solved and inverter functioning properly.

5.3.5 External AC Circuit Breaker and Residual Current Device

Please install a 2P circuit breaker to ensure the inverter is able to disconnect from grid safely. The inverter is integrated with a RCMU, however, an external RCD is needed to protect the system from tripping, either type A or type AB RCD are compatible with the inverter.

The integrated leakage current detector of inverter is able to detect the real time external current leakage. When a leakage current detected exceeds the limitation the inverter will be disconnected from grid quickly, if an external leakage current device is connected, the action current should be 300mA or higher.

Inverter type	Recommended breaker specification
R5-0.7K/1K/1.K/2K/2.5K/3K-S1 R5-0.7K/1K/1.K/2K/2.5K/3K-S1-15	25A
R5-3K/3.6K/4K/5K/6K-S2 R5-3K/3.6K/4K/5K/6K-S2-15	40A
R5-7K/8K-S2 & R5-7K/8K-S2-15	63A
Notice: Do not connect multiple inverters to one AC circuit breaker.	

Table 5.6 Recommended breaker specification

5.3.6 Multiple Inverter Combinations

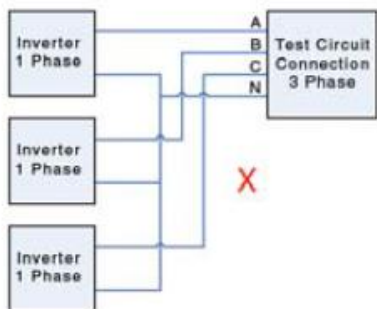

Multiple inverter combinations are not allowed.

5.4 DC Side Connection

Cross-sectional area of cables (mm ²)		Outside diameter of the cables (mm)
Scope	Recommended value	
4.0-6.0	4.0	4.2-5.3

Table 5.7 Recommended specifications of DC cables

DC connector is made up of positive connector and negative connector

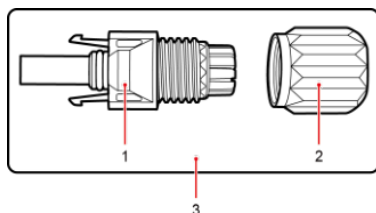

Figure 5.12 Positive connector

1. Insulated enclosure 2. Lock screw 3. Positive connector

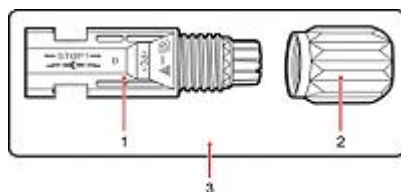

Figure 5.13 Negative connector

1. Insulated enclosure 2. Lock screw 3. Negative connector

! NOTICE

- Please place the connector separately after unpacking in order to avoid confusion for connection of cables.
- Please connect the positive connector to the positive side of the solar panels, and connect the negative connector to the negative side of the solar side. Be sure to connect them in right position.

Connecting Procedures:

1. Tighten the lock screws on positive and negative connector.
2. Use specified strip tool to strip the insulated enclosure of the positive and negative cables with appropriate length.

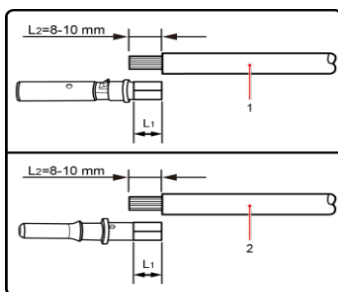

1. Positive cable

2. Negative cable

Figure 5.14 Connecting cables

3. Feed the positive and negative cables into corresponding lock screws.
4. Insert the positive and negative connectors into positive cable and negative cable whose insulated enclosure has been stripped off, and crimp them tightly with a wire crimper. Make sure that the withdrawal force of the pressed cable is bigger than 400N.
5. Plug in the pressed positive and negative cables into relevant insulated enclosure, a “click” sound should be heard when the contact cable assembly is seated correctly.
6. Fasten the lock screws on positive and negative connectors into respective insulated enclosure and make them tight.
7. Connect the positive and negative connectors into positive and negative DC input terminals of the inverter, a “click” sound should be heard when the contact cable assembly is seated correctly.

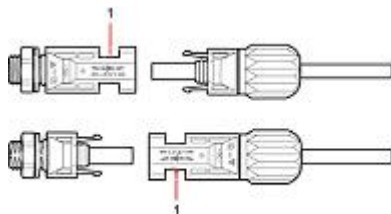

1. Connection port

Figure 5.15 Connect the inverter



NOTICE

- Before inserting the connector into DC input terminal of the inverter, please make sure that the DC switch of the inverter is OFF.
- Please use the original MC4 terminal to install.

5.5 Communication Connection

R5 inverter is standardly equipped with a RS485 interface, a DRM interface and a RS232 interface.

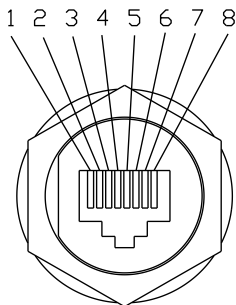

Figure 5.16 RS485 pin and DRM pin

Pin Number	Description	Function
1	White-orange	NC
2	Orange	GND_W
3	White-green	+7V_W
4	Blue	NC
5	White-blue	NC
6	Green	NC
7	White-brown	RS485-A
8	Brown	RS485-B

Table 5.8 RS485 pin port definition

Pin No.	Name
1	NC
2	NC
3	NC
4	NC
5	REF GEN
6	COM LOAD
7	NC
8	NC

Table 5.9 Demand Response Modes (DRM)

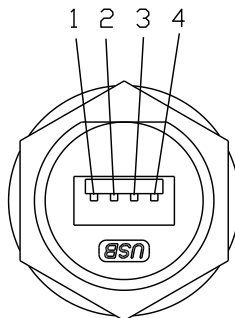

Figure 5.17 RS232 pin

Pin Number	Description	Effect
1	+7V	Power supply
2	RS-232 TX	Send data
3	RS-232 RX	Receive data
4	GND	Ground wire

Table 5.10 USB pin port definition

1. USB interface could be externally connected with eSolar GPRS/4G module, for operation in details please refer to eSolar GPRS/4G module Quick Installation Guide in <https://www.saj-electric.com/>.
2. USB interface could be externally connected with eSolar WiFi module, for operation in details please refer to eSolar WiFi module Quick Installation Guide in <https://www.saj-electric.com/>.

5.6 Start up and Shut down

5.6.1 Start up the inverter

1. Follow the installation standard from previous chapter strictly to connect the photovoltaic panels and AC power grid to inverter.
2. Using multimeter to check whether AC side and DC side voltage have met the inverter start voltage.
3. Turn ON DC switch (if applicable), LED indicators will be lit up.
4. Select country grid code, please contact your local grid operator for which region to select). Inverter will be in self-testing mode, if inverter has met all the grid connecting condition, inverter will connect to grid and generate power automatically.

5.6.2 Shut down the inverter

1. Automatically shut down, when the solar light intensity is not strong enough during sunrise and sunset or the output voltage of photovoltaic system is less than the minimum input power of inverter, inverter will shut

down automatically.

2. Shut down manually, disconnect AC side circuit breaker first, if multiple inverters are connected, disconnect the minor circuit breaker prior to disconnection of main circuit breaker. Disconnect the DC switch after inverter has reported grid connection lost alarm.

5.7 Self-test (Italy only)

Italian Standard CEI0-21 requires a self-test function for all inverter that connected to utility grid. During the self-testing time, inverter will check the reaction time for over frequency, under frequency, overvoltage and undervoltage. This self-test is to ensure the inverter is able to disconnect from grid when required. If the self-test fails, the inverter will not able to feed into the grid.

The steps of running Self-test are as followed:

Step 1:

Connect a communication module (Wi-Fi/ 4G/ Ethernet) with inverter (connection procedure can refer to eSolar Module Quick Installation Manual)

Step 2:

Select Italy for Country and choose your corresponding Grid Code from Initial Setting.









	device maintenance	>
	Initial Setting	>
	InvWaveCheck Set	>
	Protection data	>
	Feature data	>
	Power adjustment	>
	Communication	>
	Export limitation setting	>
	Self-test	>

Figure5.18 Local connection

Step 3:**Start Self-test**

You can choose self-test item required. Individual self-test time is approx. 5 minutes. All self-test time is approx. 40 minutes. After the self-test is completed, you can save the test report. If self-test is failed, please contact with SAJ or your inverter supplier.

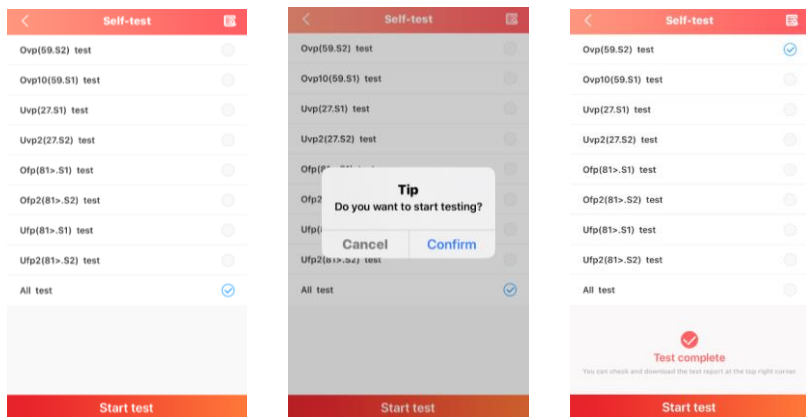

Figure5.19 Self testing

Chapter 6 Debugging Instructions

6.1 Introduction of Human-computer Interface

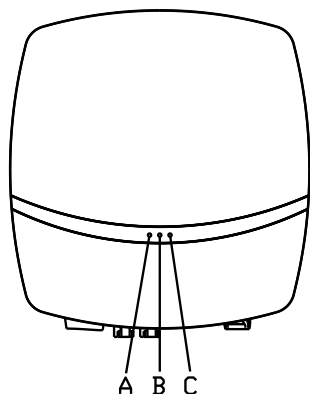

Figure 6.1 Human-computer interface

A/B/C are double-color LED lamps which could show green light or red light at the same time

Indicator lamp	LED indicators state		Description
A&B&C	Green	Blinking : 1 s/time	The inverter is in the initialization or waiting state.
		Solid	The inverter is in normal on-grid state.
	Red	Solid	Inverter is reporting fault.
	Blinks green and red alternatively		Inverter software is upgrading.

Table 6.1 Interface description

6.2 Monitoring Operation

- There is no LCD display screen in R5 series products and they could be monitored through eSolar APP.
- This equipment is standardly equipped with a USB interface which could transfer GPRS/4G module (with built-in Bluetooth) and Wi-Fi module to monitor running state of the equipment.

6.2.1 APP Introduction

eSolar could achieve communication with the equipment via Bluetooth, GPRS/4G and Wi-Fi and it is an APP for nearby and remote monitoring.

Download APP

Installers using iOS system could search for “eSolar O&M” in App Store and download this App.

Installers using Android system could search for “eSolar O&M” in Google play and download this App.

For iOS/Android system, installers could visit SAJ eSolar O&M Portal: <https://fop.saj-electric.com> and scan the QR code to download eSolar O&M APP.

Account---Please use the installer account to login.

Note: For the end user, please download and install the “eSolar Air” APP and log in to the APP or SAJ eSolar O&M Portal to register your account.

6.2.2 Nearby Monitoring

Connecting way 1 — Bluetooth connection

After installing the eSolar GPRS/4G module (with built-in Bluetooth) the mobile phone could be directly connected with the inverter via Bluetooth.

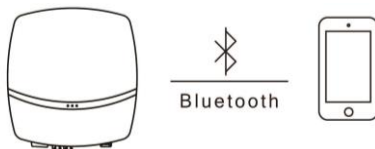

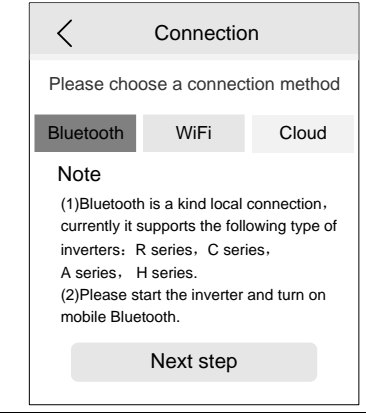

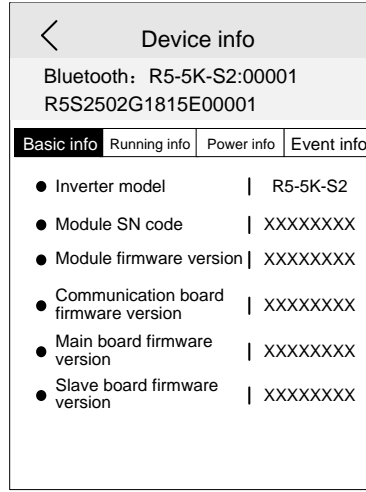

Figure 6.2 Bluetooth connection schematic diagram



Connection setting

iOS system operation steps

<p>1. Choose "setting" → choose "Bluetooth" → open "Bluetooth"</p>	<p>2. Log in APP → choose "My" interface → choose "Remote control" → choose connection way as "Bluetooth"</p>																												
																													
<p>3. Choose "next step" → search for equipment → click the Bluetooth name matched with the inverter (eg.: R5-5K-S2:00001)</p>	<p>4. Connect successfully → set country and grid code for first start-up → after inverter start, users can view inverter's info.</p>																												
	 <table border="1" data-bbox="544 961 926 1258"> <thead> <tr> <th>Basic info</th> <th>Running info</th> <th>Power info</th> <th>Event info</th> </tr> </thead> <tbody> <tr> <td>● Inverter model</td> <td colspan="3"> R5-5K-S2</td> </tr> <tr> <td>● Module SN code</td> <td colspan="3"> XXXXXXXX</td> </tr> <tr> <td>● Module firmware version</td> <td colspan="3"> XXXXXXXX</td> </tr> <tr> <td>● Communication board firmware version</td> <td colspan="3"> XXXXXXXX</td> </tr> <tr> <td>● Main board firmware version</td> <td colspan="3"> XXXXXXXX</td> </tr> <tr> <td>● Slave board firmware version</td> <td colspan="3"> XXXXXXXX</td> </tr> </tbody> </table>	Basic info	Running info	Power info	Event info	● Inverter model	R5-5K-S2			● Module SN code	XXXXXXXX			● Module firmware version	XXXXXXXX			● Communication board firmware version	XXXXXXXX			● Main board firmware version	XXXXXXXX			● Slave board firmware version	XXXXXXXX		
Basic info	Running info	Power info	Event info																										
● Inverter model	R5-5K-S2																												
● Module SN code	XXXXXXXX																												
● Module firmware version	XXXXXXXX																												
● Communication board firmware version	XXXXXXXX																												
● Main board firmware version	XXXXXXXX																												
● Slave board firmware version	XXXXXXXX																												

Connection setting

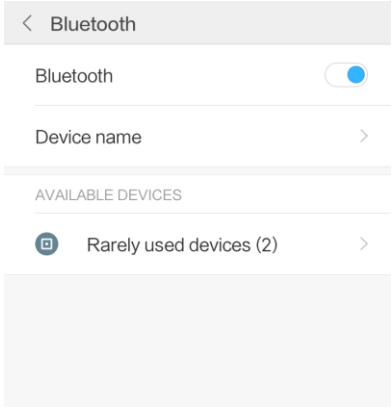
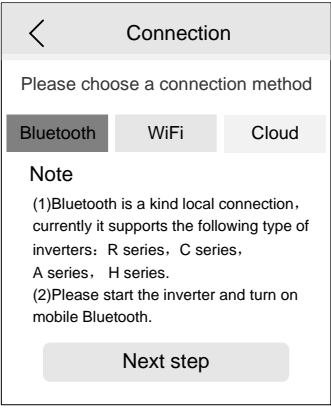
Android system operation steps

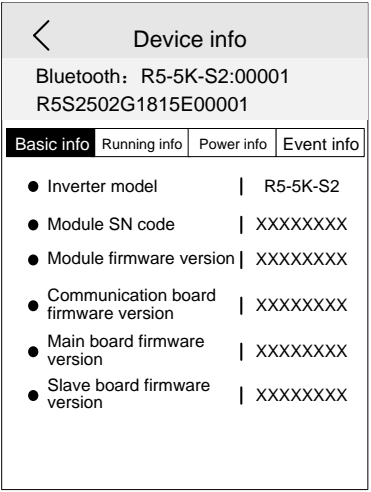
<p>1.Choose "setting" →choose "Bluetooth"→ open "Bluetooth"</p>	<p>2.Log in APP → choose "My" interface → choose "Remote control" → choose connection way as "Bluetooth "</p>																												
																													
<p>3.Choose "next step" → search for equipment → click the Bluetooth name matched with the inverter (ex.: R5-5K-S2:00001)</p>	<p>4. Connect successfully→set country and grid code for first start-up→after inverter start, users can view inverter's info.</p>																												
	 <table border="1" data-bbox="540 961 930 1258"> <thead> <tr> <th>Basic info</th> <th>Running info</th> <th>Power info</th> <th>Event info</th> </tr> </thead> <tbody> <tr> <td>● Inverter model</td> <td colspan="3"> R5-5K-S2</td> </tr> <tr> <td>● Module SN code</td> <td colspan="3"> XXXXXXXX</td> </tr> <tr> <td>● Module firmware version</td> <td colspan="3"> XXXXXXXX</td> </tr> <tr> <td>● Communication board firmware version</td> <td colspan="3"> XXXXXXXX</td> </tr> <tr> <td>● Main board firmware version</td> <td colspan="3"> XXXXXXXX</td> </tr> <tr> <td>● Slave board firmware version</td> <td colspan="3"> XXXXXXXX</td> </tr> </tbody> </table>	Basic info	Running info	Power info	Event info	● Inverter model	R5-5K-S2			● Module SN code	XXXXXXXX			● Module firmware version	XXXXXXXX			● Communication board firmware version	XXXXXXXX			● Main board firmware version	XXXXXXXX			● Slave board firmware version	XXXXXXXX		
Basic info	Running info	Power info	Event info																										
● Inverter model	R5-5K-S2																												
● Module SN code	XXXXXXXX																												
● Module firmware version	XXXXXXXX																												
● Communication board firmware version	XXXXXXXX																												
● Main board firmware version	XXXXXXXX																												
● Slave board firmware version	XXXXXXXX																												

6.2.3 Initial set up

Select the initial setting. Please contact your local grid operator for which grid code to select

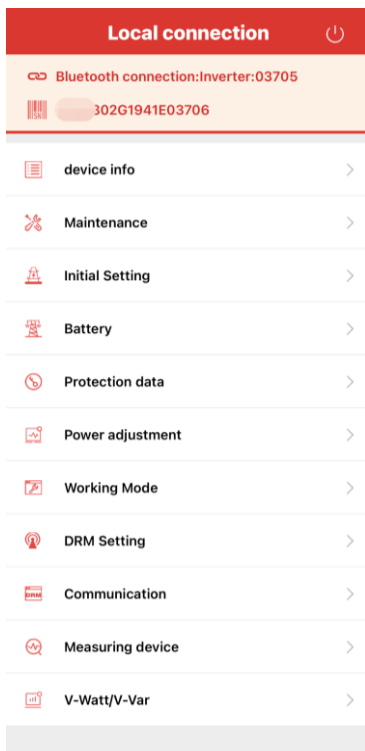

Fig. 6.3 Main interface

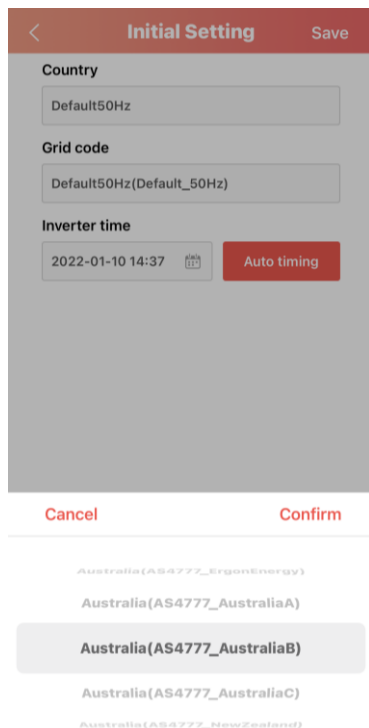

Fig. 6.4 Grid code selection

6.2.4 Equipment information

Connection way, running state, basic information, running information, Power information and events information of the communication of the inverter could be checked.

1. Click “Basic info”

Inverter model, Module SN code, Module firmware version, Communication board firmware version, Main board firmware version, Slave board firmware version could be checked.

Device info			
Bluetooth: R5-5K-S2:00001 R5S2502G1815E00001			
Basic info	Running info	Power info	Event info
● Inverter model		R5-5K-S2	
● Module SN code		XXXXXXXX	
● Module firmware version		XXXXXXXX	
● Communication board firmware version		XXXXXXXX	
● Main board firmware version		XXXXXXXX	
● Slave board firmware version		XXXXXXXX	

Fig. 6.5 Basic information

2. Click “Running info”

PV information (voltage and current at PV terminal), Grid power information (voltage, current and frequency at AC terminal), etc.

Device info			
Bluetooth: R5-5K-S2:00001 R5S2502G1815E00001			
Basic info	Running info	Power info	Event info
PV information			
PV1	XXV	XXA	
PV2	XXV	XXA	
PV3	N/V	N/A	
Grid power information			
AC1	XXV	XXA	XXHz
AC2	N/V	N/A	N/Hz
AC3	N/V	N/A	N/Hz
Battery information			
CT1	N/V	N/A	N/W
CT2	N/V	N/A	N/W
CT3	N/V	N/A	N/W

Fig. 6.6 Running information

3. Click "Power info"

Current power, today energy, monthly energy, yearly energy and total energy could be checked.

Device info	
Bluetooth: R5-5K-S2:00001 R5S2502G1815E00001	
Basic info	Running info
Power info	Event info
Read More	
Current power	XXX
Today Energy	XXX
Monthly Energy	XXX
Yearly Energy	XXX
Total Energy	XXX

Fig. 6.7 Power information

4. Click “Event info”

Time of the events, events sequence number (referring to fault codes details in Chapter 7 Fault Codes and Common Troubleshooting) and events content of the faults of the inverter could be checked.

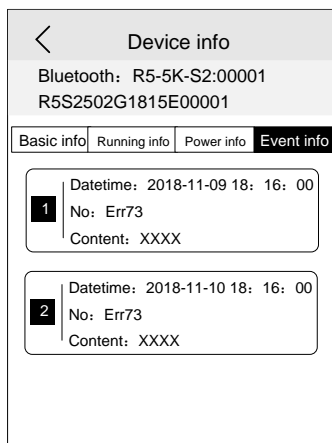

Fig. 6.8 Events information

Connecting way 2 — Wi-Fi connection

After installing the eSolar WiFi module, the mobile phone could be directly connected with the inverter via Wi-Fi.



Figure 6.9 Wi-Fi connection schematic diagram

Connection setting

Please refer to the eSolar WiFi module operating manual for more details in operation.

Equipment information

Connection way, running state, basic information, running information, power information and events information of the communication of the inverter could be checked.

1. Click “Basic info”

Inverter model, Module SN code, Module firmware version, Communication board firmware version, Main board firmware version, Slave board firmware version could be checked.

2. Click “Running info”

PV information (voltage and current at PV terminal), Grid power information (voltage, current and frequency at AC terminal), etc.

3. Click “Power info”

Current power, today energy, monthly energy, yearly energy, total energy could be checked.

4. Click “Event info”

Time of the events, events sequence number(referring to fault codes details in Chapter 7 Fault Codes and Common Troubleshooting) and events content of the faults of the inverter could be checked.

6.2.5 Remote Monitoring

1. Connect the internet via the eSolar GPRS/4G module, and upload the inverter data onto the server and customers could monitor running information of the inverter remotely via the eSolar Web Portal or their mobile customer terminals.
2. Connect the internet via the eSolar WiFi module, and upload the inverter data onto the server and customers could monitor running information of the inverter remotely via the eSolar Web Portal or their mobile customer terminals.

6.3 Export Limitation Setting

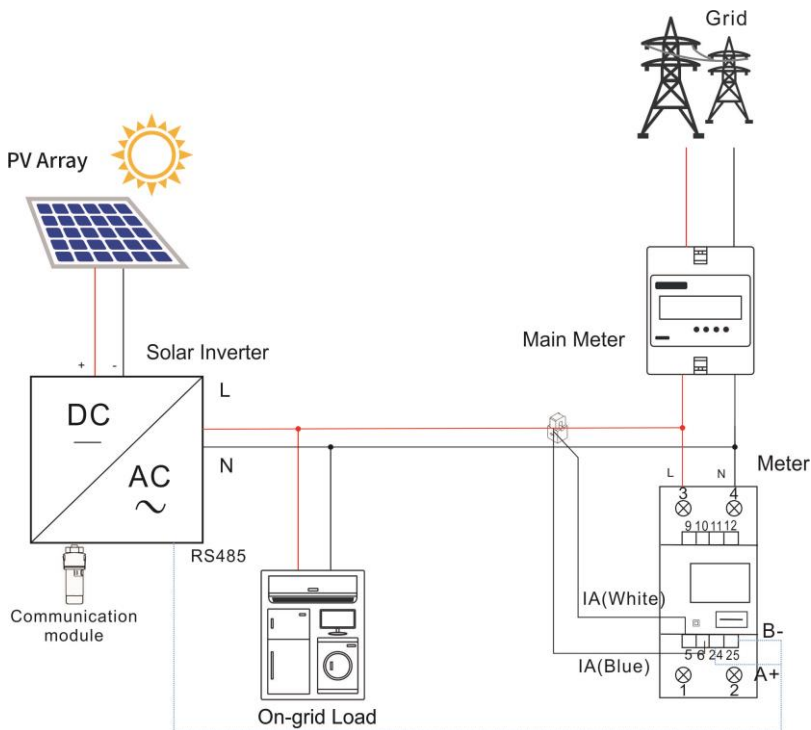

Figure 6.10 Export limitation system schematic

6.3.1 APP Setting

Enter the main page of local connection and click on Export limitation setting, enter the password “201561”.

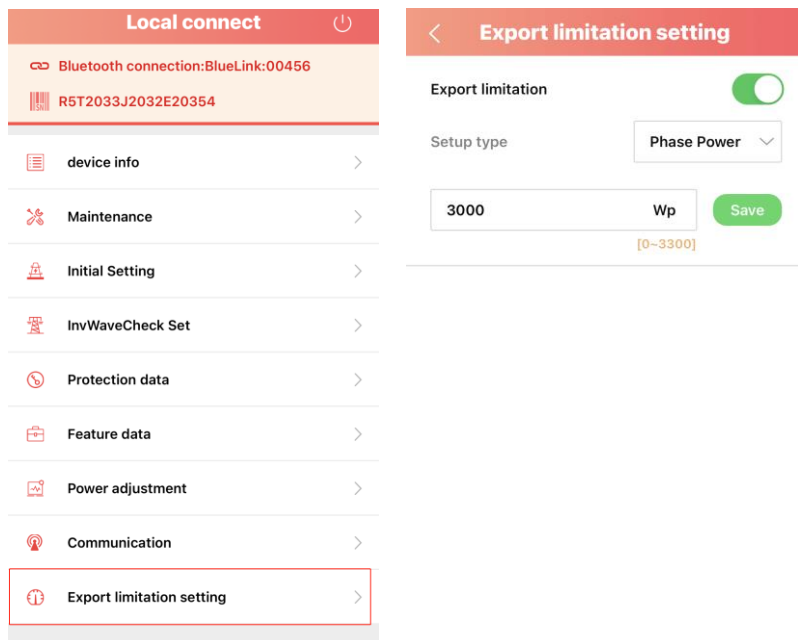

Fig. 6.11 Export limitation APP setting

Chapter 7 Fault Code and Troubleshooting

Error Code	Explanation
01	Relay Error Master
02	Storer Error Master
03	High Temperature Master
04	Low Temperature Master
05	Interior Communication Error Master
06	GFCI Devices Error Master
07	DCI Devices Error Master
08	Current Sensor Error Master
09	Grid Over Voltage Master
10	Grid Low Voltage Master
15	High average voltage of 10 minutes Master
18	Over Frequency Master
19	Low Frequency Master
24	Grid Lost Error Master
27	GFCI Error Master
28	DCI Error Master
31	Insulation Error Master
33	Over Bus Voltage Master
34	Under Bus Voltage Master
35	Overcurrent Master
38	Bus Hardware Overvoltage Master
39	PV1 Hardware Overcurrent Master
40	PV2 Hardware Overcurrent Master
41	Hardware Overcurrent Master
44	Null line voltage to earth fault Master
45	Fan Error Master
49	Loss of communication between Power Meter and Control Board Master
50	Interior Communication Error Slave

Error Code	Explanation
51	Voltage Consistency Error Slave
54	Frequency Consistency Error Slave
57	GFCI Consistency Error Slave
61	Overvoltage Slave
62	Under Voltage Slave
67	Over Frequency Slave
68	Under Frequency Slave
73	Grid Lost Error Slave
76	PV1 Overvoltage Slave
77	PV2 Overvoltage Slave
81	Loss of Communication between Display Panel and Control Board Master
86	DRM0 Error Master

Table 7.1 Error Code

General troubleshooting methods for inverter are as follows:

Fault Information	Troubleshooting
Relay Error	If this error occurs frequently, please contact your distributor or call SAJ technical support.
Storer Error	If this error occurs frequently, please contact your distributor or call SAJ technical support.
High Temperature Error	Check whether the radiator is blocked, whether the inverter is in too high or too low temperature. If the above mentioned are in normal, please contact your distributor or call SAJ technical support.
GFCI Device Error	If this error occurs frequently, please contact your distributor or call SAJ technical support.
DCI Device Error	If this error occurs frequently, please contact your distributor or call SAJ technical support.
Current Sensor Error	If this error occurs frequently, please contact your distributor or call SAJ technical support.
AC Voltage Error	·Check the volt of the grid. ·Check the connection between the inverter and the grid.

Fault Information	Troubleshooting
	<p>·Check the settings of the on-grid standards of the inverter.</p> <p>·If the volt. of the grid is higher than the volt. regulated by local grid, please inquire the local grid workers whether they can adjust the volt. at the feed point or change the value of the regulated volt.</p> <p>If the volt. of the grid is in regulated range as allowed and monitoring portal still shows this error, please contact your distributor or call SAJ technical support.</p>
Frequency Error	Check the setting of country and frequency of the local grid, if the above mentioned are in normal, please contact your distributor or call SAJ technical support.
Grid Lost Error	Check the connection status between the AC side of the inverter and the grid, if the above mentioned are in normal, please contact your distributor or call SAJ technical support.
GFCI Error	Check the insulation resistance of the positive side and negative side of the solar panel; check whether the inverter is in wet environment; check the grounding of the inverter. If the above mentioned are in normal, please contact your distributor or call SAJ technical support.
DCI Error	If this error always exists, please contact your distributor or call SAJ technical support.
ISO Error	Check the insulation resistance of the positive side and negative side of the solar panel; check whether the inverter is in wet environment; check whether the grounding of the inverter is loose or not. If the above mentioned are in normal, please contact your distributor or call SAJ technical support.
Overcurrent	Check the connection status between the inverter and the grid and test whether the volt. of the grid is stable or not, if the above mentioned are in normal, please contact your distributor or call SAJ technical support.
Over Bus Voltage	Check the settings of the solar panel. SAJ designer can help you. If the above mentioned are in normal, please contact your distributor or call SAJ technical support.
PV Overcurrent	If this error exists always, please contact your distributor

Fault Information	Troubleshooting
	or call SAJ technical support.
PV Voltage Fault	Check the settings of the solar panel. SAJ designer can help you. If the above mentioned are in normal, please contact your distributor or call SAJ technical support.
Lost Communication	Check the connection of communication cables between control board and display board. If the above mentioned are in normal, please contact your distributor or call SAJ technical support.
Null line-to-earth voltage fault	Check if connection of the AC output grounding terminal is stable and reliable. If the condition as above is normal, please contact your distributor or call SAJ technical support.

Table 7.2 Troubleshooting

Chapter 8 Routine Maintenance

Inverter Cleaning

Clean the enclosure lid and LED indicator of the inverter with moistened cloth with clear water only. Do not use any cleaning agents as it may damage the components.

Heat Sink Cleaning

Clean the heat sink with dry cloth or air blower, Do Not clean the heat sink with water or cleaning agents. Make sure there is enough space for ventilation of inverter.

Chapter 9 Recycling and Disposal

This device should not be disposed as residential waste. An inverter that has reached the end of its life and is not required to be returned to your dealer and it must be disposed carefully by an approved collection and recycling facility in your area.

Chapter 10 Contact SAJ

Guangzhou Sanjing Electric Co., Ltd.

SAJ Innovation Park, No.9, Lizhishan Road, Guangzhou Science City, Guangdong, P.R.China.

Web: <http://www.saj-electric.com>

Technical Support & Service

Tel:+86 20 6660 8588

Fax:+86 20 6660 8589

E-mail: service@saj-electric.com

International Sales

Tel: +86 20 6660 8618/6660 8619/6660 0082/6660 0086

Fax: +86 20 6660 8589

E-mail:info@saj-electric.com

Domestic Sales

Tel: +20 6660 0058/6660 0082

Fax: +20 6660 8589

SAJ Warranty Policy

1.1 Standard Warranty Period

Guangzhou Sanjing Electric, Co., Ltd (“SAJ”) grants a standard warranty period of 66 months (5.5 years) starting from the date of shipment from SAJ factory or 60 months (5 years) starting from the date of commercial invoice marked (whichever is longer).

1.2 Extension of Warranty

The purchaser of SAJ inverters should extend the warranty period in 18 months from the date of settlement or 30 months from the date of shipment from SAJ by providing the serial number of the unit and purchased receipt (whichever is shorter). You can purchase the warranty extension for 10 years, 15 years, 20 years or 25 years but do not apply the extension beyond the specified date, or else your application will be unacceptable. Please refer to the Warranty Extension Order Form for more details.

Once the purchase of the warranty extension comes into effect, SAJ will send the warranty extension certificate to the customer for confirming the extended warranty period.

1.3 Warranty Conditions

If your inverter gets fault and requires troubleshooting, please contact your distributor or dealer directly. Alternatively, feedback briefly to SAJ service hotline for logging and send your warranty card to our service department by fax/email to process the warranty claim.

During the Warranty Period, SAJ covers all costs for replacing any product or parts of the product proved to be defective in design or manufacture. To claim the warranty under the warranty policy of SAJ, you need to supply us with the following information and documentation regarding the faulty inverter:

(1) Product Model No.(e.g. R5-3K-S2) and serial number (e.g.

R5S2302G1821E

00001).

- (2) Copy of the invoice and warranty certificate of the inverter.
- (3) Copy of the installation report and installation date.
- (4) Error message on eSolar Portal (if available) or any information which would be helpful to determine the defect.
- (5) Detailed information about the entire system (PV modules, circuits, etc.).

1.4 After receiving above information, SAJ will decide how to proceed the service

- Repaired by SAJ factory, or SAJ authorized service center overhaul.
- Repaired on-site by SAJ Service Center.
- Offer a replacement device of equivalent value according to model.

In the case of an exchange, the remaining portion of the original warranty period will be transferred to the replacement device. You will not receive a new certificate, as your entitlement is documented at SAJ.

If the inverter needs to be replaced in emergency, SAJ will send a replacement unit immediately. The defective inverter should be sent back to the closest SAJ Service Center by packing in its original package if possible.

1.5 Service after Warranty Expiration

If the inverters for maintenance are out of warranty, SAJ charges an on-site service fee, parts, labor cost and logistic fee to end-user. Detailed standard refers to the listed table.

Item	Return to Factory for Maintenance	On-site Maintenance
Without parts replacement	Labor + Logistic fee (to & from SAJ)	Labor + On-site attendance fee
With parts replacement	Labor + Parts + logistic fee (to & from SAJ)	Labor + On-site attendance fee + Parts

- On-site attendance fee: Cost of travel and time for the technician in

attending on-site.

- Parts: Cost of replacement parts (including any shipping/admin fee that may apply).
- Labor: Labor time fee charged for the technician, who is repairing, maintaining, installing (hardware or software) and debugging the faulty product.
- Logistic fee: Cost of delivery, tariff and other derived expense when defective products are sent from user to SAJ or/and repaired products are sent from SAJ to user.

1.6 Exclusion of Liability

Any defect caused by the following circumstances will not be covered by the manufacturer's warranty (the Dealers or Distributors are responsible and authorized by SAJ for the following investigation):

- ◆ "Warranty Card" not being sent back to Distributor/Dealer or SAJ;
- ◆ Product modified, parts replaced or attempt to maintain;
- ◆ Changes, or attempted repairs and erasing of series number or seals by non SAJ technician;
- ◆ Incorrect installation or commissioning;
- ◆ Failure in complying with the safety regulations (VDE standards, etc.);
- ◆ The inverter has been improperly stored and damaged while being stored by the Dealer or the end user;
- ◆ Transport damage (including scratch caused by movement inside packaging during shipping). A Claim should be made directly to shipping company/insurance Company as soon as the container/packaging is unloaded and such damage is identified;
- ◆ Failure in following any / all of the user manual, the installation guide and the maintenance regulations;
- ◆ Improper use or misuse of the inverter;

- ◆ Insufficient ventilation of the inverter;
- ◆ Influence of foreign objects and force majeure (lightning, grid overvoltage, severe weather, fire, etc.)

Warranty Card

The installer should fill in the second form while installing the inverter. For warranty claim, please complete the below forms and send this page to SAJ, attached with the Customer's invoice.

For customer to fill in

Name:		
City:	Country:	Zip:
Tel:	Fax:	E-mail:

Information on device

Device type:	Serial No.(S/N):
Invoice No:	Commissioning date:
Fault time:	
Error message (Display reading):	
Brief fault description & photo:	
Signature: _____ Date: _____	



For installer to fill in

Modules used:		
Modules per string:	No. of string:	
Installation company:	Contractor license number:	
Company:		
City:	Country:	Zip:
Tel:	Fax:	E-mail:
Signature: _____ Date: _____		





Guangzhou Sanjing Electric CO., LTD.

ADD: SAJ Innovation Park, No.9, Lizhishan Road, Science City,
Tel: +86 20 6660 8588 Zip : 510663 Fax: +86 20 6660 8589
Web: <http://www.saj-electric.com>

- Due to the continuous improvement of products, technical parameters in this manual are modified without prior notice.

V3.0